



agricarb.com



Catalogue 2025

Catalog | Katalog | Catálogo

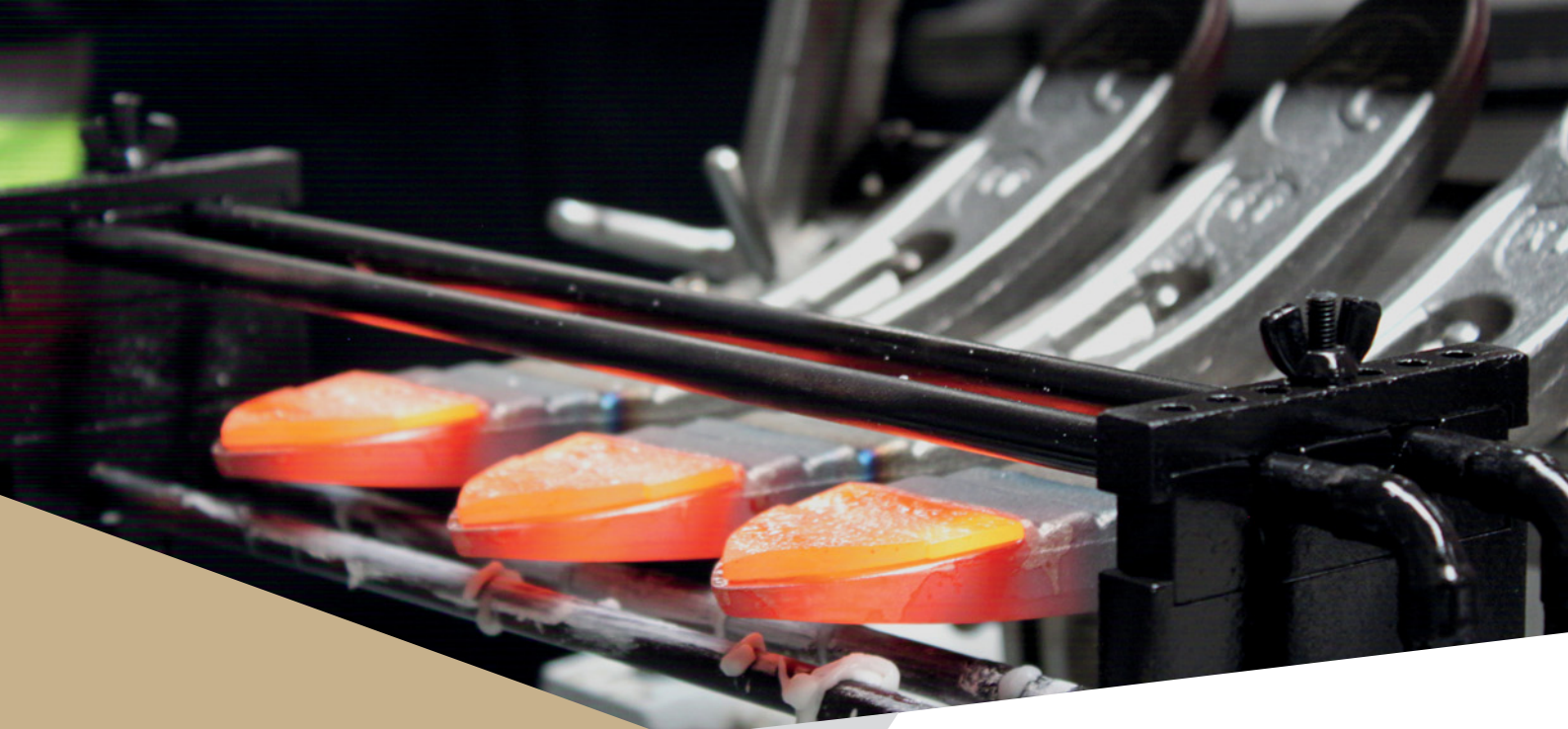

de la pièce d'usure au carbure de tungstène depuis plus de 40 ans
the leading producer of tungsten carbide wear parts for 40 years,
french manufacturer and european leader

seit 40 jahren die nummer 1 bei verschleißteilen aus hartmetall,
französischer hersteller und europäischer marktführer

de la pieza de desgaste con carburo de tungsteno desde 40 años,
fabricante francés y líder europeo



SAVOIR-FAIRE **KNOW-HOW - SABER HACER**

- ▲ Inventeur de la pièce d'usure agricole au carbure de tungstène
- ▲ Inventor of tungsten carbide agricultural wear part
- ▲ Erfinder des landwirtschaftlichen Verschleißteils mit Hartmetall
- ▲ Inventor de la pieza de desgaste agrícola con carburo de tungsteno



SERVICE **SERVICIO**

- ▲ 2500 m² de stockage
- ▲ Plus de 2000 produits en stock
- ▲ 2500 m² storage capacity
- ▲ Over 2000 products in stock
- ▲ Logistikkager mit 2500 m²
- ▲ Über 2000 Produkte am Lager
- ▲ Logística de 2500 m²
- ▲ Más de 2000 productos en stock



INNOVATION **INNOVACIÓN - INNOVATION**

- ▲ Seul fabricant à maîtriser ses plaquettes carbure
- ▲ Plus de 200 modèles de plaquettes sur-mesure
- ▲ Unité de Recherche & Développement
- ▲ Conception unique de pièces
- ▲ The only manufacturer to master the production of its carbide tips
- ▲ Over 200 made-to-measure models
- ▲ Unique design ensuring maximum durability of parts
- ▲ Eigene Herstellung der Hartmetallplatten für unsere Verschleißteile
- ▲ Über 200 maß-geschneiderte Modelle
- ▲ Höchste Lebensdauer der Produkte
- ▲ Único fabricante que produce sus propias plaquitas de carburo
- ▲ Más de 200 modelos a medida
- ▲ Servicio de Investigación y Desarrollo
- ▲ Un diseño único de las piezas



AGRICARB

- **Durée de vie 3 à 7 fois supérieure à celle de l'acier**
- **Géométrie des pièces conservées pour un travail régulier**

- Carbide parts last 3 to 7 times longer than steel parts
- The geometry of carbide parts remains unchanged, ensuring a uniform, high quality result

- Im Vergleich zu Verschleißteilen aus Stahl eine 3 bis 7 mal längere Standzeit
- Die Geometrie der Hartmetallteile bleibt erhalten und garantiert so eine gleichmäßig hohe Arbeitsqualität

- Vida útil de 3 a 7 veces superior con respecto al acero
- La geometría de las piezas se conserva para un trabajo uniforme



INDUSTRIEL DE RÉFÉRENCE

*INDUSTRIAL DE REFERENCIA
REFERENZHERSTELLER
A LEADIND PRODUCER*

- ▲ **Usine de production de 3500 m²**
- ▲ **Usine dédiée à la fabrication de nos plaquettes carbure**
- ▲ 3500 m² factory
- ▲ Dedicated factory for the production of our carbide tips
- ▲ Großproduktion in einem 3500 m² großen Herstellungswerk
- ▲ Ein weiteres Werk für die Herstellung unserer Hartmetallplatten
- ▲ Fábrica de producción de piezas de 3500 m²
- ▲ Fábrica dedicada a la producción de nuestras plaquitas de carburo



PROXIMITÉ

*CERCANÍA - KUDENNÄHE
PROXIMITY*

- ▲ **Référencé auprès de 2500 revendeurs**
- ▲ **Référencé dans plus de 30 pays**
- ▲ **15 Technico-commerciaux sur le terrain à votre service**
- ▲ stocked by 2500 retailers
- ▲ in over 30 countries
- ▲ More than 15 technical sales representatives at your service
- ▲ Bei 2500 Händlern im Sortiment
- ▲ In über 30 Ländern vertreten
- ▲ Über 15 Außendienst Mitarbeiter stehen Ihnen vor Ort zur Verfügung
- ▲ Comercializado por 2500 distribuidores
- ▲ Comercializado en más de 30 países
- ▲ 15 técnicos-comerciales sobre el terreno a su servicio





« Grâce à sa forte valeur ajoutée et à son expertise reconnue dans le domaine des outils hybrides en acier et carbure de tungstène, AgriCarb enrichit notre division Hard Material Solutions d'un savoir-faire technologique de pointe », affirme Frank Thomé, membre du directoire CERATIZIT Group.

“Thanks to its high added value and recognized expertise in hybrid tools combining steel and tungsten carbide, AgriCarb significantly enhances our Hard Material Solutions division with cutting-edge technological expertise”, says Frank Thomé, member of the Ceratizit Group Executive Board.



Siège social

Mamer, Luxemburgo

Depuis plus de 100 ans, Ceratizit conçoit des solutions innovantes à base de matériaux durs pour l'usinage et la protection contre l'usure. Basé à Mamer, au Luxembourg, ce groupe privé développe et fabrique une gamme d'outils de coupe hautement spécialisés, comprenant des plaquettes de coupe, des barreaux en matériaux durs et des pièces d'usure. Leader mondial dans plusieurs segments, le groupe Ceratizit repousse régulièrement les limites en développant de nouvelles nuances de carbure, cermet et céramique, adaptées notamment aux industries du bois, du métal et de la pierre.

AgriCarb, fort de ses 40 années d'expérience, s'impose comme l'un des leaders européens dans la fabrication de pièces d'usure renforcées en carbure pour le secteur agricole.

L'intégration d'AgriCarb au sein de l'offre de Ceratizit représente une complémentarité idéale et une opportunité stratégique de développement dans le domaine agricole, grand utilisateur de pièces d'usure.

« Grâce à sa forte valeur ajoutée et à son expertise reconnue dans le domaine des outils hybrides en acier et carbure de tungstène, AgriCarb enrichit notre division Hard Material Solutions d'un savoir-faire technologique de pointe », affirme Frank Thomé, membre du directoire CERATIZIT Group.

De son côté, AgriCarb bénéficie désormais des capacités de production élargies du groupe et de son service de recherche et développement à la pointe de l'innovation, équipé d'outils analytiques ultramodernes. Ce partenariat ouvre la voie à la création de solutions encore plus innovantes et contribue à accroître durablement la productivité du secteur agricole.

For over 100 years, Ceratizit has been designing innovative solutions based on hard materials for machining and wear protection. Headquartered in Mamer, Luxembourg, this private group develops and manufactures a range of highly specialized cutting tools, including cutting inserts, hard material rods, and wear parts. A global leader in several segments, the Ceratizit Group consistently pushes boundaries by developing new grades of carbide, cermet, and ceramics, tailored specifically for industries such as wood, metal, and stoneworking.

With 40 years of experience, AgriCarb stands out as one of Europe's leading manufacturers of carbide-reinforced wear parts for the agricultural sector.

The integration of AgriCarb into Ceratizit's portfolio marks a perfect complementarity and a strategic opportunity to grow in the agricultural sector, a major consumer of wear parts.

“Thanks to its high added value and recognized expertise in hybrid tools combining steel and tungsten carbide, AgriCarb significantly enhances our Hard Material Solutions division with cutting-edge technological expertise”, says Frank Thomé, member of the Ceratizit Group Executive Board.

For its part, AgriCarb now benefits from the group's expanded production capabilities and its state-of-the-art research and development services, equipped with cutting-edge analytical tools. This partnership paves the way for the creation of even more innovative solutions and contributes to sustainably boosting productivity in the agricultural sector.



30 sites de production
production sites
Produktionsstandorte
plantas de producción



30% de produits développés au cours des 5 dernières années
of products developed in the last 5 years
Produkte die jünger als 5 Jahre sind
de productos desarrollados en los últimos 5 años



2 00 collaborateurs dans la R&D
R&D employees
Mitarbeiter in F&E
empleados en I+D



80 pays où nous sommes actifs
Countries in which we are active
Produktionsstandorte
Países en los que operamos



7 000 collaborateurs
employees
Mitarbeiter
empleados



25 prix de l'innovation
innovation awards
Innovationspreise
premios a la innovación



1 000 brevets et modèles
patents & utility models
Patente und Gebrauchsmuster
patentes y modelos de utilidad



1 00 000 produits
products
Produkte
productos



€1.5 bn de chiffre d'affaires
turnover
Umsatz
de facturación

SOMMAIRE

CONTENTS | ZUSAMMENFASSUNG | SUMARIO



NOUVEAUTÉS
NEW PRODUCT
NEUES PRODUKT
NUEVO PRODUCTO

6



DÉCHAUMAGE
CULTIVATION
STOPPELBEARBEITUNG
CULTIVADOR

10



SOUS-SOLAGE
SUBSOILING
UNTERGRUNDLOCKERUNG
SUBSOLADOR

44



LABOUR
PLOUGHING
PFLÜGEN
LABOREO

64



PRÉPARATION DU SOL
SOIL PREPARATION
BODENBEARBEITUNG
PREPARACIÓN DEL SUELO

92



SEMIS/RÉCOLTE
SEEDING/CROP
SÄEN/ERNTE
SIEMBRA/COSECHA

124



VIGNE
VINEYARD EQUIPMENT
WEINBAU
VIÑA

134



MISES À SOUDER
WELD-ON PARTS
ANSCHWEISSTEILE
PIEZAS DIVERSAS PARA SOLDAR

152



**BOULONS & PRODUITS
DE SOUDAGE**
BOLTS & WELDING PRODUCTS
SCHRAUBEN & SCHWEISSUNG
TORNILLOS & PRODUCTOS DE SOLDAD

164



CGV
GENERAL TERMS
AND CONDITIONS

170

INDEX | INDICE

172

RÉSEAU COMMERCIAL 178
COMMERCIAL NETWORK
VERTRIEBSNETZ
RED COMERCIAL



2025 ÉVOLUTION PRODUIT
EVOLUCIÓN PRODUCTO | PRODUKTVERBESSERUNG | PRODUCT IMPROVEMENT



Tous nos prix sont exprimés en euros hors taxes (€ HT).

Les prix indiqués sont susceptibles d'être modifiés en cours d'année sans préavis de notre part. Photos, visuels et informations non contractuels. TOUTE REPRODUCTION EST INTERDITE. RÉSERVE DE PROPRIÉTÉ - De convention collective expresse. Nos marchandises demeurent notre propriété jusqu'au paiement intégral de leur prix. Loi N° 80.335 du 12 mai 1980.

All prices are in euros and exclude VAT (€ HT).

Prices subject to change throughout the year without prior notice. Property clause – All products remain the property of Agricarb until full payment has been received. Law N° 80.335 from 12th May 1980.

Alle Preise sind im euros und verstehen sich inkl. MWST (€ HT).

Die angegebene Preise können sich ohne Vorankündigung im Lauf des Jahres ändern. Eigentumsvorbehalt – Die Ware bleiben bis zur völligen Zahlung Eigentum von Agricarb. Gesetz Nr.80.335 vom 12. Mai 1980.

Todos los precios son en euros y sin IVA (€ HT).

Los precios indicados pueden ser modificados durante el año sin preaviso. Fotos, imágenes y noticias no contractuales. Reserva de propiedad - Conforme a la ley francesa N° 80.335 del 12 mayo de 1980, nuestras mercancías quedan nuestra propiedad hasta el pago integro del precio.



NOUVEAUTÉS

New | Neuheiten | Novedades

2025



CERATIZIT GROUP



DÉCHAUMAGE

CULTIVATION | STOPPELBEARBEITUNG | CULTIVADOR



SMB0446 - p.11



SCH0080A - p.12 - 22



SCK6064A - p.16 - 20



BDK7920P - p.18



SMV5996 - p.24



BDA8765-40 - p.25



STL0066 - p.39



STL0080 - p.39



STT0260 - p.40



DÉCHAUMAGE

CULTIVATION | STOPPELBEARBEITUNG | CULTIVADOR



SOUS-SOLAGE

SUBSOILING | UNTERGRUNDLOCKERUNG | SUBSOLADOR



STT0300 - p.40

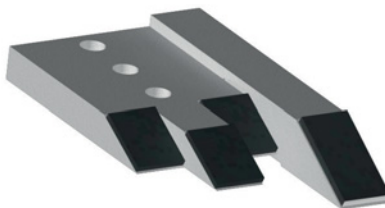

VAGR0131 - p.46



CMA4225-L - p.50



DÉCHAUMAGE
CULTIVATION
STOPPELBEARBEITUNG
CULTIVADOR



SOUS-SOLAGE
SUBSOILING
UNTERGRUNDLOCKERUNG
SUBSOLADOR



LABOUR
PLOUGHING
PFLÜGEN
LABOREO



PRÉPARATION DU SOL
SOIL PREPARATION
BODENBEARBEITUNG
PREPARACIÓN DEL SUELO



LABOUR

PLOUGHING | PFLÜGEN | LABOREO



ETG3461G - p.70

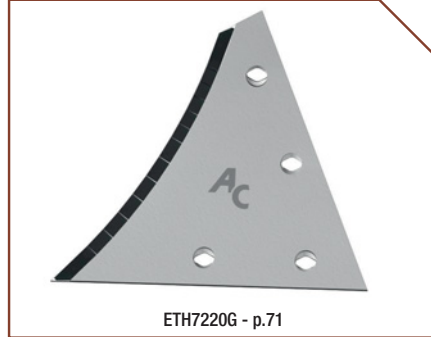

ETH7220G - p.71



ETL1031G - p.72



RAL3729 - p.84



CSD3491 - p.86



CSD3563 - p.86



PRÉPARATION DU SOL

SOIL PREPARATION | BODENBEARBEITUNG | PREPARACIÓN DEL SUELO



DHAL0470-OD - p.92

DHAL0470-LTD - p.92



DHA2980-OD - p.93

DHA2980-OLT - p.93



VIGNE

VINEYARD EQUIPMENT | WEINBAU | VIÑA

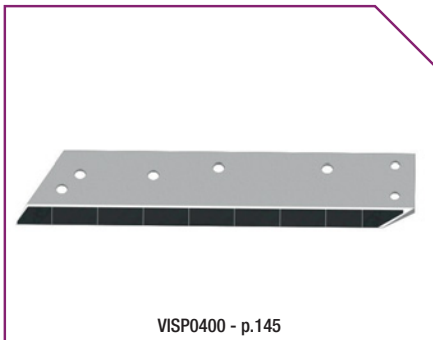

VISP0400 - p.145

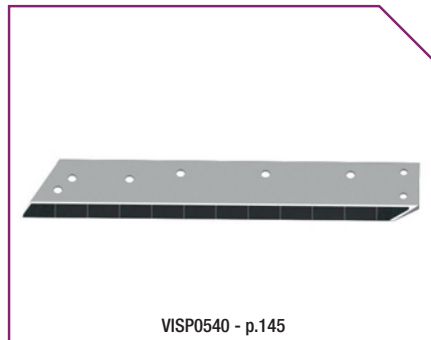

VISP0540 - p.145



SEMIS/RÉCOLTE
SEEDING/CROP
SÄEN/ERNT
SIEMBRA/COSECHA



VIGNE
VINEYARD EQUIPMENT
WEINBAU
VIÑA



MISES À SOUDER
WELD-ON PARTS
ANSCHWEISSTELLE
PIEZAS DIVERSAS PARA SOLDAR



Déchaumage Cultivation

Stoppelbearbeitung
Cultivador





▲ **Becs de déchaumage** **10**

Stubble points

Schare und spitzen

Puntas de cultivador

▲ **Socs de chisels** **26**

Chisel points

Grubberschare

Rejas de chisel

▲ **Ailerons de déchaumage** **30**

Stubble wings

Flügelschare

Alas de cultivador

▲ **Socs triangulaires** **38**

Duckfoot points

Gänsefußschare

Rejas de golondrinas

1 BDU2065C



BDU2065C

260	70	25	48	BTFC1290
				€
BDU2065C				73,53

Agromulch / Cross, Kos Premium

6 BDL220V



BDL220V

200	120	20	/	BTFC1240
				€
BDL220V				103,08

Pegasus / Delta / Smaragd / Terremoto / CTM

2 SCA1660B



SCA1660B

245	80	20	/	BTFC1290
				€
SCA1660B				68,18

Puma, Cayman

7 SCA8676



SCA8676G

285	80	28	45-70	BTFC1260 BTFC1280
				€
SCA8676G	SCA8676D			95,70

Genius, Centaur

3 SCH0080P-HY



SCH0080P-HY

313	90			BTHX1270
				€
SCH0080P-HY	SCH0080P-HY			115,43

Cayman / Terrano, Terrano SFX 2023 / Black Bear

8 SCA8677



SCA8677G

495	80	28	45-70	BTFC Ø 12 mm
				€
SCA8677G	SCA8677D			104,11

Genius, Centaur

4 BDA8765



BDA8765

550	60	20	70	BTFC1280
				€
BDA8765	BDA8765			63,04

Genius

9 SCA8734C



SCA8734C

300	80	28	70	BTFC1260 BTFC1280
				€
SCA8734C				73,51

Genius

5 BDAD8765



BDAD8765

340,4	60	38		BTFC1280
				€
BDAD8765				20,13

Genius

10 SCAD8676



SCAD8676G

364	80	28	/	BTFC1255 BTFC1270 / 1280
				€
SCAD8676G	SCAD8676D			26,14

Genius



11 SCB0427P

SCB0427P

↕	↔	↗	↻	⊕
274	90	37	64	BTFC1290
< >				€
SCB0427P				83,10
Fenix, Actros, Terraland				

12 SCH0080C

SCH0080C

↕	↔	↗	↻	⊕
255	80	27	57	BTFC1290 BTFC12100
< >				€
SCH0080C				69,28
SCH0080C-R				89,43
Fénix (2019) / Champion / Apollo / Néotiller, Maxitiller, Vakitiller / Blackbear				

13 SCH0080P

SCH0080P

↕	↔	↗	↻	⊕
270	90	42	57	BTFC1290 BTFC12100
< >				€
SCH0080P				83,10
SCH0080P-R				91,30
Fénix (2019) / Terrano, Tiger / Blackbear				

14 SCHD0080

SCHD0080G

↕	↔	↗	↻	⊕
386	80	20,5	57	BTFC1290
< >				€
SCHD0080G	SCHD0080D	25,37		
Fénix / Terrano, Tiger				

15 SMB0446

NEW

SMB0446

↕	↔	↗	↻	⊕
460	50	32	64-58	BTHX1290-OB
< >				€
SMB0446	SMB0446	173,05		
Fenix, Actros, Terraland				

CORRESPONDANCE CORRESPONDENCIA KORRESPONDENZ CORRESPONDENCE					
		<		>	
N°	TYPE TIP TYP	AGRICARB	ORIGINE	AGRICARB	ORIGINE
1	Agrisem	BDU 2065C	1103622 1103551	BDU 2065C	1103622 1103551
2	Alpego	SCA 1660B	D16600 MK0A00278	SCA 1660B	D16600 MK0A00278
3		SCH0080P-HY		SCH0080P-HY	
4		BDA 8765	78708765	BDA 8765	78708765
5		BDAD 8765	78708765	BDAD 8765	78708765
6		BDL 220V	XL0018	BDL 220V	XL0018
7	Amazone	SCA 8676G	78708676	SCA 8676D	78708677
8		SCA 8677G	78708676	SCA 8677D	78708677
9		SCA 8734C		SCA 8734C	
10		SCAD 8676G	78708677	SCAD 8676D	78708676
11		SCB 0427P	KM060427 KM060437	SCB 0427P	KM060427 KM060437
12	Bednar	SCH 0080C-R	KM060334	SCH 0080C-R	KM060334
13		SCH 0080P	KM060334	SCH 0080P	KM060334
14		SCHD 0080G		SCHD 0080D	
15		SMB 0446	KM060446 KM060437 KM060427	SMB 0446	KM060446 KM060437 KM060427

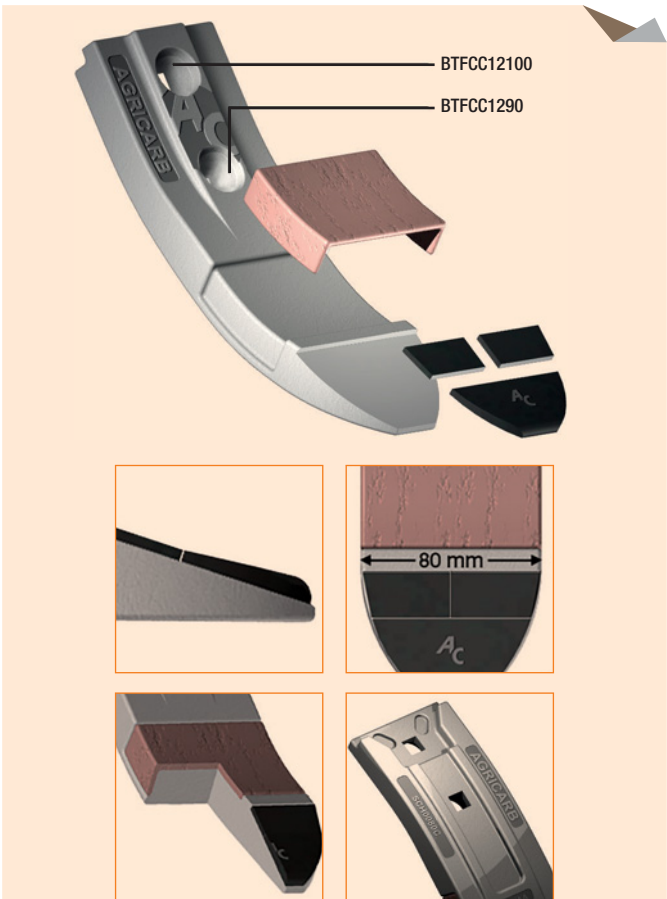

16 BDB8237



BDB8237

370	80	20	65	BTFC1260
				€
BDB8237				92,31

20 BDL4441C



BDL4441C

300	80	27	131,5	BTFC1290 Ø 12 mm
				€
BDL4441C				73,53
BDL4441C-R				92,77

Onatar / Karat, Kristall

17 SCH0080A

NEW



SCH0080A

260	80	33	57	BTFC1290 BTFC12100
				€
SCH0080A				65,95

Champion / Apollo / Néotiller, Maxitiller, Vakitiller / Blackbear

21 BDL4441P



BDL4441P

320	90	38	131,5	BTFC1290 Ø 12 mm
				€
BDL4441P				86,06

Onatar / Karat, Kristall

13 SCH0080P



SCH0080P

270	90	42	57	BTFC1290 BTFC12100
				€
SCH0080P				83,10
SCH0080P-R				91,30

Fénix (2019) / Terrano, Tiger / Blackbear

22 BDL4442



BDL4442

320	120	18	/	BTFC1280
				€
BDL4442				103,08

Onatar / Karat, Kristall

18 SCH0080B



SCH0080B

260	80	32	57	BTFC1290 BTFC12100
				€
SCH0080B				65,51

Champion / Apollo / Néotiller, Maxitiller, Vakitiller / Blackbear

23 BDF2317C



BDF2317C

271	80	20	/	BTFC1270
				€
BDF2317C				73,53

Duolent, Triolent, Terrix, Triton, Fertis

19 BDL4441B



BDL4441B

240	80	20	/	BTFC1240
				€
BDL4441B		BDL4441B		68,18

Onatar / Karat, Kristall

24 BDG3417C



BDG3417C

272	80	20	57	BTFC1290 Ø 12 mm
				€
BDG3417C				77,41

Crossland



25 BDG8392



↑	↔	↗	↻	⊕
200	60	31	100	/
				€
BDG8392				66,60
BDG8392-R				93,28

Discodent / Combitrak, Carrybret

3 SCH0080P-HY



↑	↔	↗	↻	⊕
313	90			BTHEX1270
				€
SCH0080P-HY		SCH0080P-HY		115,43

Cayman / Terrano, Terrano SFX 2023 / Black Bear

26 SCH1177



↑	↔	↗	↻	⊕
300	50	30	45	BTFCC1040
				€
SCH1177				60,84

Cruiser

27 SCH1357



↑	↔	↗	↻	⊕
420	25		57	BTFCC12120
				€
SCH1357				161,88

Pointe ULD

28 SCH1358



↑	↔	↗	↻	⊕
391	108	45		BTCHC12150
				€
SCH1358				107,02

Pointe ULD

CORRESPONDANCE CORRESPONDENCIA KORRESPONDENZ CORRESPONDENCE					
		<		>	
N°	TYPE TIP TYP	AGRICARB	ORIGINE	AGRICARB	ORIGINE
16	Bourbonnais	BDB 8237		BDB 8237	
17	Bremer	SCH 0080A		SCH 0080A	
18		SCH 0080B		SCH 0080B	
12		SCH 0080C		SCH 0080C-R	
13		SCH 0080P	KM060334	SCH 0080P-R	KM060334
19	Carré	BDL 4441B	50316909	BDL 4441B	50316909
20		BDL 4441C	50316909	BDL 4441C-R	50316909
21		BDL 4441P	50316909	BDL 4441P	50316909
22		BDL 4442	50316901	BDL 4442	50316901
23	Farmet	BDF 2317C	3002317	BDF 2317C	3002317
24	Grégoire-Besson	BDG 3417C	M340090 M340117	BDG 3417C	M340090 M340117
25		BDG 8392	850108392	BDG 8392-R	850108392
17		SCH 0080A	34060850 311069	SCH 0080A	34060850 311069
18	SCH 0080B	34060850 311069	SCH 0080B	34060850 311069	
12	SCH 0080C	3406850 00311069	SCH 0080C-R	3406850 00311069	
13	SCH 0080P	34060850 00311069	SCH 0080P-R	34060850 00311069	
3	Horsch	SCH0080P-HY		SCH0080P-HY	
26		SCH 1177	00311177 00311102	SCH 1177	00311177 00311102
27		SCH 1357	00311357 311357	SCH 1357	00311357 311357
28		SCH 1358	00311358 311358	SCH 1358	00311358 311358
29		SCH 1512	311512	SCH 1512	311512
30		SCH 1514	311514	SCH 1514	311514



29 SCH1512



SCH1512

300	50	30	45	BTFCC1240
				€
SCH1512				60,84

Cruiser

33 SMH2200



SMH2200

457	50	16	57	BTHEX1290-OB x2
				€
SMH2200				173,05

Focus/ Terrano

30 SCH1514



SCH1514

320	90	36	45	BTFCC1245
				€
SCH1514				83,10

Cruiser

34 BDK2229



BDK2229

200	100	20	/	BTFCC1660-NY
				€
BDK2229				82,46

Komet

31 SCH2217



SCH2217

505	50	27	57	BTFCC1290
				€
SCH2217				77,90
SCH2217-R				97,37

Terrano, Focus

35 BDK2229V



BDK2229V

221	100	20	/	BTFCC1660-NY
				€
BDK2229V				99,54

Komet

32 SCH5006



SCH5006

200	45	10	45	BTFCC1035
				€
SCH5006				45,89

Rollfex

36 BDK2230



BDK2230

200	80	20	/	BTFCC1660-NY
				€
BDK2230				68,18

Komet

14 SCHD0080



SCHD0080G

386	80	20,5	57	BTFCC1290
				€
SCHD0080G		SCHD0080D		25,37

Fénix / Terrano, Tiger

37 SCK3032



SCK3032

360	60	20	70	BTC2M1690-NY BTC2M16115-NY
				€
SCK3032				62,46

Cultivateur lourd-Non-stop



38 SCK6348

↕	↔	↗	↻	⊕
480	60	30	75	BTFHC1490 BTFHC14130
SCK6348				€
				118,80
DM				



SCK6348

39 SCK7238

↕	↔	↗	↻	⊕
380	70	20	75	BTFHC1690-NY BTFHC16120- NY
SCK7238				€
				75,63
Cultivateur lourd				



SCK7238

40 BDK1245C

↕	↔	↗	↻	⊕
450	100	20	70	BTFCC1260
BDK1245C				€
				93,29
Vario				



BDK1245C

41 BDK6068

↕	↔	↗	↻	⊕
520	50	23	114-114	BTFCC1290
BDK6068				€
				90,04
BDK6068-R				€
				109,53
Trio, Quadro, Vector				



BDK6068

42 BDK9430

↕	↔	↗	↻	⊕
450 (190)	60	20	70	BTFCC1240
BDK9430				€
				59,73



BDK9430

CORRESPONDANCE CORRESPONDENCIA KORRESPONDENZ CORRESPONDENCE					
		<	>		
N°	TYPE TIP TYP	AGRICARB	ORIGINE	AGRICARB	ORIGINE
31		SCH 2217	24221700 311113 311114 311350	SCH 2217-R	24221700 311113 311114 311350
32	Horsch	SCH 5006	34265006	SCH 5006	34265006
14		SCHD 0080G	34060858	SCHD 0080D	34060859
33		SMH 2200	24152200	SMH 2200	24152200
17		SCH 0080A	10300120	SCH 0080A	10300120
18	Iligi	SCH 0080B	10300120 10300110	SCH 0080B	10300120 10300110
12		SCH 0080C	10300120 10300111	SCH 0080C-R	10300120 10300111
17		SCH 0080A	1191201 1191211	SCH 0080A	1191201 1191211
18	Jean-de-Bru	SCH 0080B	1191201 1191211	SCH 0080B	1191201 1191211
12		SCH 0080C	1191201 1191211	SCH 0080C-R	1191201 1191211
34		BDK 2229	1092229 1092224	BDK 2229	1092229 1092224
35	Kerner	BDK 2229V	1092229	BDK 2229V	1092229
36		BDK 2230	1092230	BDK 2230	1092230
37		SCK 3032	2093032	SCK 3032	2093032
38	Kirpy	SCK 6348		SCK 6348	
39		SCK 7238	2093032	SCK 7238	2093032
40		BDK 1245C	919430 506008 506006	BDK 1245C	919430 506008 506006
41	Kockerling	BDK 6068	506068 915774	BDK 6068-R	506068 915774
42		BDK 9430	919430 506008 506006	BDK 9430	919430 506008 506006

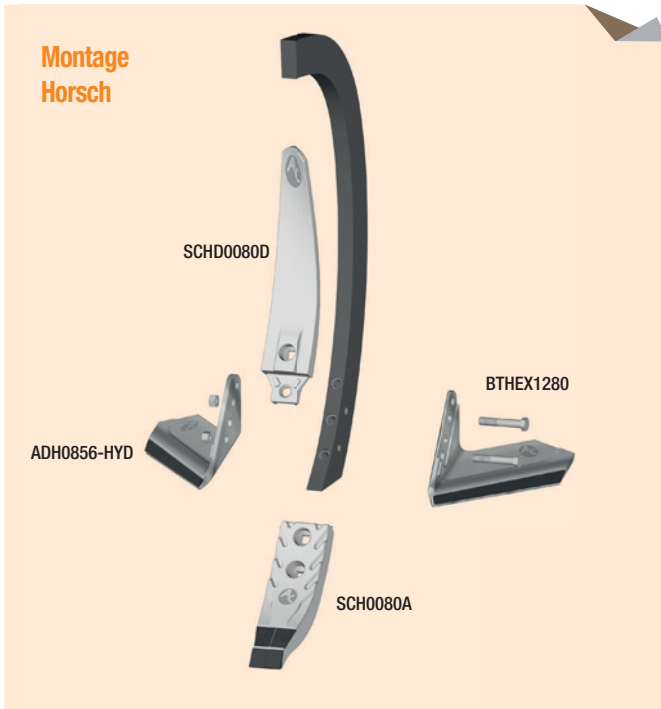

43 BDKD9430



267	60	31,5		Ø 12 mm
				€
BDKD9430		BDKD9430		20,13

BDKD9430 Vario

48 SCKD6064



365	80	28	/	BTFC1290
				€
SCKD6064G		SCKD6064D		23,82

SCKD6064G Trio, Quadro, Vector

44 SCK6064A

NEW



260	80	20	/	BTFC1290
				€
SCK6064A				68,95

SCK6064A Trio, Quadro, Vector / Dracula, Furia

49 SCKD6064N



365	80	28	/	BTFC1290
				€
SCKD6064N				23,82

SCKD6064N Trio, Quadro, Vector

45 SCK6064B



260	80	20	/	BTFC1290
				€
SCK6064B				68,18

SCK6064B Trio, Quadro, Vector

50 SMK6064



450	50	20	113	BTH1290-OB
				€
SMK6064				173,05

SMK6064 Trio, Quadro, Vector

46 SCK6064C



260	80	18	113	BTFC1290
				€
SCK6064C				70,66
SCK6064C-R				90,49

SCK6064C Trio, Quadro, Vector

51 BDK5247



470	50	20	100	BTFC Ø 12 mm
				€
BDK5247				94,58

BDK5247 Deltaflex

47 SCK6064P



335	90	42	113	BTFC1240 BTFC12100
				€
SCK6064P				84,80

SCK6064P Trio, Quadro, Vector

6 BDL220V



200	120	20	/	BTFC1240
				€
BDL220V				103,08

BDL220V Pegasus / Delta / Smaragd / Terremoto / CTM



52 SCK0552



SCK0552

↑↓	↔	↔	↔	⊕
165	110	28	40	BTFC1250
SCK0552				€ 59,92
Vibro Till, Vibro Seeder				

53 SCK0792



SCK0792

↑↓	↔	↔	↔	⊕
283	110	22	45	BTFC1260
SCK0792				€ 59,92
Vibroflex				

54 SCK0800



SCK0800

↑↓	↔	↔	↔	⊕
283	65	22	45	BTFC1260
SCK0800				€ 53,18
Vibroflex				

55 SCK3120C



SCK3120C

↑↓	↔	↔	↔	⊕
270	80	20	/	BTFC1290
SCK3120C				€ 73,53
Delta flex				

56 BDK7920B



BDK7920B

↑↓	↔	↔	↔	⊕
245	80	25	45	BTFC1290
BDK7920B				€ 68,18
Cultimer				

CORRESPONDANCE CORRESPONDENCIA KORRESPONDENZ CORRESPONDENCE					
		◀		▶	
N°	TYPE TIP TYP	AGRICARB	ORIGINE	AGRICARB	ORIGINE
43		BDKD 9430	919430	BDKD 9430	919430
44		SCK 6064A	506065 506069	SCK 6064A	506065 506069
45		SCK 6064B	506065 506069	SCK 6064B	506065 506069
46	Kockerling	SCK 6064C	506065 506069 915776	SCK 6064C-R	506065 506069 915776
47		SCK 6064P	506065 506069 915776	SCK 6064P	506065 506069 915776
48		SCKD 6064G	907024	SCKD 6064D	907024
49		SCKD 6064N	907020	SCKD 6064N	907020
50		SMK 6064	506065	SMK 6064	506065
51	Kongskilde	BDK 5247	105000579	BDK 5247	105000579
6		BDL 220V	71209026470	BDL 220V	71209026470
52	Kongskilde-New Holland	SCK 0552	101000552 101000915	SCK 0552	101000552 101000915
53		SCK 0792	105000792 105000794	SCK 0792	105000792 105000794
54		SCK 0800	105000800	SCK 0800	105000800
55		SCK 3120C	101003120	SCK 3120C	101003120
56	Kuhn-Huard	BDK 7920B	2212540 2217920 2220760 2220761	BDK 7920B	2212540 2217920 2220760 2220761



57 BDK7920C



BDK7920C

260	80	25	45	BTFCC1290
				€
BDK7920C				73,53

Cultimer

62 PBS0188



PBS0188G

240	70	20	40	BTC2M1239
				€
PBS0188G	PBS0188D	39,52		

CLC

58 BDK7920P

NEW



BDK7920P

260	80	31	45	BTFCC1290
				€
BDK7920P				86,06

Cultimer

6 BDL220V



BDL220V

200	120	20	/	BTFCC1240
				€
BDL220V				103,08

Pegasus / Delta / Smaragd / Terremoto / CTM

59 SOC213V



SOC213V

420	100	20	45-80	BTFCC1480
				€
SOC213V				114,62

Mixter

63 BDL0220



BDL0220

180	120	30	/	BTFCC1240
				€
BDL0220				82,46

Smaragd

60 BDK3050



BDK3050

220	50	20	40	BTC2M1250 BTC2M1264
				€
BDK3050				59,36

CLC, CTC

64 BDL4386



BDL4386

450	80	15	45-80	BTFCC1270
				€
BDL4386				103,08

Thorit

61 BDK3090



BDK3090

220	70	25	40	BTFCC1240
				€
BDK3090				63,73

CLC, CTC / NSL

19 BDL4441B

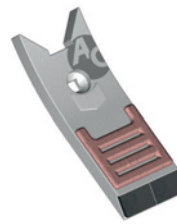

BDL4441B

240	80	20	/	BTFCC1240
				€
BDL4441B	BDL4441B	68,18		

Onatar / Karat, Kristall



20 BDL4441C



↑↓	↔	↔	↔	⊕
300	80	27	131,5	BTFCF Ø 12 mm
				€
BDL4441C				73,53
BDL4441C-R				92,77

BDL4441C

Onatar / Karat, Kristall

21 BDL4441P



↑↓	↔	↔	↔	⊕
320	90	38	131,5	BTFCF Ø 12 mm
				€
BDL4441P				86,06

BDL4441P

Onatar / Karat, Kristall

22 BDL4442



↑↓	↔	↔	↔	⊕
320	120	18	/	BTFCF1280
				€
BDL4442				103,08

BDL4442

Onatar / Karat, Kristall

65 BDL7106



↑↓	↔	↔	↔	⊕
490	60	20	131,5	BTFCF1280
				€
BDL7106				87,78

BDL7106

Kristall

66 BDL8012



↑↓	↔	↔	↔	⊕
450	155	15	54-60	BTFCF1280
				€
BDL8012				113,67

BDL8012

Smaragd

CORRESPONDANCE | CORRESPONDENCIA | KORRESPONDENZ | CORRESPONDENCE

N°	TYPE I TIP I TYP	AGRICARB	ORIGINE	AGRICARB	ORIGINE
57	Kuhn-Huard	BDK 7920C	2217920 2212540 H2225650	BDK 7920C	2217920 2212540 H2225650
58		BDK 7920P	2217920 2212540 H2225650	BDK 7920P	2217920 2212540 H2225650
59		SOC 213V	622227	SOC 213V	622227
60	Kverneland	BDK 3050	053090 063090	BDK 3050	053090 063090
61		BDK 3090	KK053090 KK063090	BDK 3090	KK053090 KK063090
62		PBS 0188D	63090	PBS 0188G	63090
63	6	BDL 0220	3374388 3374391	BDL 0220	3374388 3374391
64		BDL 220V	3374388 3374391	BDL 220V	3374388 3374391
19	Lemken	BDL 4386	3374386	BDL 4386	3374386
20		BDL 441B	3374441 33710008 33710031	BDL 441B	3374441 33710008 33710031
21		BDL 4441C	3374441 33710008 33710031	BDL 4441C-R	3374441 33710008 33710031
22		BDL 4441P	3374441 33710008 33710031	BDL 4441P	3374441 33710008 33710031
65		BDL 4442	3374441 33710008 33710031	BDL 4442	3374441 33710008 33710031
66		BDL 7106	33710006	BDL 7106	33710006
		BDL 8012	3374438	BDL 8012	3374438

Prestation de rechargement
Welding service / Schweissleistungen / Prestación de soldadura



PSRBD-80
Prestation de rechargement sur becs de déchaumeur 80 mm
Application of hardfacing on cultivator points 80 mm
Anwendung von Hartauftrag auf Grubberspitzen 80 mm
Prestación de soldadura sobre puntas de cultivador de 80mm de anchura

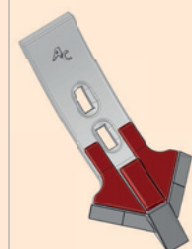

PSRSC-33
Prestation de rechargement sur socs de chisels
Application of hardfacing on Anwendung von Hartauftrag auf
Prestación de soldadura sobre rejas de chisel
SCU3312, SCU3314, SCC3312-H, SCC3314-H



PSRSC-70
Prestation de rechargement sur socs de chisels
Application of hardfacing on Anwendung von Hartauftrag auf
Prestación de soldadura sobre rejas de chisel
SCU7012, SCC7012-H, BDL4386

Retrouvez toutes nos prestations page 160 | Find out about all our services on page 160 | Informieren Sie sich über alle unsere Dienstleistungen auf Seite 160 | Descubra todos nuestros servicios en la página 160.

67 BDL4441N



BDL4441N

340	80	29	/	BTFC Ø 12 mm
				€
BDL4441N				25,37

Karat, Kristall

72 SML4441



SML4441

455	50	20	131,5	BTHX1280-0B (Classic)
				€
SML4441				170,48

Karat

68 SCL5420



SCL5420

450	60	20	45	BTFC1260
				€
SCL5420				81,07

Karat

6 BDL220V



BDL220V

200	120	20	/	BTFC1240
				€
BDL220V				103,08

Pegasus / Delta / Smaragd / Terremoto / CTM

69 SDL4021-INF

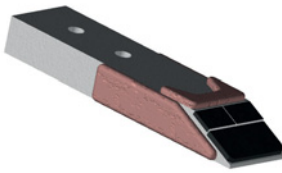

SDL4021-INF

240	60	30	50	BTCHC1225
				€
SDL4021-INF				115,24

KARAT Montage rapide

44 SCK6064A

NEW



SCK6064A

260	80	20	/	BTFC1290
				€
SCK6064A				68,95

Trio, Quadro, Vector / Dracula, Furia

70 SDL4021-INF-25

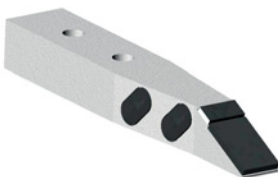

SDL4021-INF-25

240	40/25	30	50	BTCHC1225
				€
SDL4021-INF-25				102,90

KARAT Montage rapide

45 SCK6064B

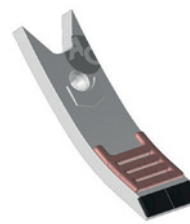

SCK6064B

260	80	20	/	BTFC1290
				€
SCK6064B				68,18

Trio, Quadro, Vector

71 SDL4021-SUP



SDL4021-SUP

400	220	60		
				€
SDL4021-SUP				141,78

KARAT Montage rapide

47 SCK6064P



SCK6064P

335	90	42	113	BTFC1240 BTFC12100
				€
SCK6064P				84,80

Trio, Quadro, Vector



61 BDK3090



220 70 25 40 BTFC1240

BDK3090 63,73

CLC, CTC / NSL

73 SC08225C



250 80 18 / BTFC1290

SC08225C 66,82

Versatill

74 BDP0151B



288 80 20 45 BTFC1290

BDP0151B 68,18

Synkro / Terra

75 BDP0151C



285 80 20 45 BTFC1290

BDP0151C 73,53

Synkro / Terra

76 BDP0151P



318 90 42 45 BTFC1290

BDP0151P 86,06

Synkro / Terra

CORRESPONDANCE CORRESPONDENCIA KORRESPONDENZ CORRESPONDENCE					
		<		>	
N°	TYPE TIP TYP	AGRICARB	ORIGINE	AGRICARB	ORIGINE
67	Lemken	BDLD 4441N	3374482	BDLD 4441N	3374482
68		SCL 5420	3375420	SCL 5420	3375420
69		SDL 4021-INF		SDL 4021-INF	
70		SDL 4021-INF-25		SDL 4021-INF-25	
71		SDL 4021-SUP		SDL 4021-SUP	
72		SML 4441		SML 4441	
6	Maschio	BDL 220V	F20100026	BDL 220V	F20100026
44		SCK 6064A		SCK 6064A	
45		SCK 6064B		SCK 6064B	
46		SCK 6064C		SCK 6064C-R	
47	SCK 6064P	R180020177	SCK 6064P	R180020177	
61	Ovlac	BDK 3090	1664000033 1664000034	BDK 3090	1664000033 1664000034
73		SCO 8225C		SCO 8225C	
74	Pöttinger	BDP 0151B	9762500151	BDP 0151B	9762500151
75		BDP 0151C	9762500151	BDP 0151C	9762500151
76		BDP 0151P	9762500151	BDP 0151P	9762500151

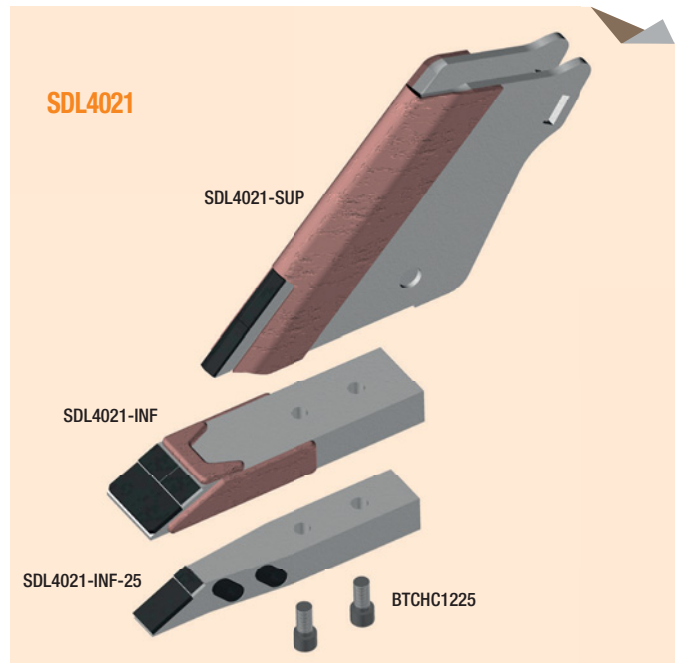

77 BDP5248



480	50	20	45	BTFC1270
				€
BDP5248				79,71

BDP5248
Synkro / Terria

18 SCH0080B



260	80	32	57	BTFC1290 BTFC12100
				€
SCH0080B				65,51

SCH0080B
Champion / Apollo / Néotiller, Maxitiller, Vakitiller / Blackbear

78 SMP0151



455	50	22	45-60	BTHX1280-OB
				€
SMP0151				173,05

SMP0151
Synkro

12 SCH0080C

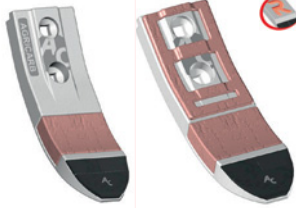

255	80	27	57	BTFC1290 BTFC12100
				€
SCH0080C				69,28
SCH0080C-R				89,43

SCH0080C
Fénix (2019) / Champion / Apollo / Néotiller, Maxitiller, Vakitiller / Blackbear

61 BDK3090



220	70	25	40	BTFC1240
				€
BDK3090				63,73

BDK3090
CLC, CTC / NSL

13 SCH0080P



270	90	42	57	BTFC1290 BTFC12100
				€
SCH0080P				83,10
SCH0080P-R				91,30

SCH0080P
Fénix (2019) / Terrano, Tiger / Blackbear

79 BDQ2214



180	120	20	/	BTFC1460
				€
BDQ2214				84,15

BDQ2214

3 SCH0080P-HY



313	90			BTHX1270
				€
SCH0080P-HY				115,43

SCH0080P-HY
Cayman / Terrano, Terrano SFX 2023 / Black Bear

17 SCH0080A

NEW



260	80	33	57	BTFC1290 BTFC12100
				€
SCH0080A				65,95

SCH0080A
Champion / Apollo / Néotiller, Maxitiller, Vakitiller / Blackbear

25 BDG8392



200	60	31	100	/
				€
BDG8392				66,60
BDG8392-R				93,28

BDG8392
Discodent / Combitrak, Carrybret



80 BDR0310



BDR0310

↕	↔	↗	↻	⚙️			
410	100	20	45-75	BTFC1270			
<table border="1"> <tr> <td><</td> <td>></td> <td>€</td> </tr> </table>				<	>	€	
<	>	€					
BDR0310				87,99			
⚙️							

81 BDR310V



BDR310V

↕	↔	↗	↻	⚙️			
410	100	20	50-75	BTFC1270			
<table border="1"> <tr> <td><</td> <td>></td> <td>€</td> </tr> </table>				<	>	€	
<	>	€					
BDR310V				117,83			
⚙️							

82 BDR1667



BDR1667

↕	↔	↗	↻	⚙️			
230	80	20	45	BTFC1280			
<table border="1"> <tr> <td><</td> <td>></td> <td>€</td> </tr> </table>				<	>	€	
<	>	€					
BDR1667				91,59			
⚙️							
Makila							

83 BDR200V



BDR200V

↕	↔	↗	↻	⚙️			
200	100	20	/	BTFC1280			
<table border="1"> <tr> <td><</td> <td>></td> <td>€</td> </tr> </table>				<	>	€	
<	>	€					
BDR200V				99,53			
⚙️							
Aramix							

6 BDL220V



BDL220V

↕	↔	↗	↻	⚙️			
200	120	20	/	BTFC1240			
<table border="1"> <tr> <td><</td> <td>></td> <td>€</td> </tr> </table>				<	>	€	
<	>	€					
BDL220V				103,08			
⚙️							
Pegasus / Delta / Smaragd / Terremoto / CTM							

CORRESPONDANCE CORRESPONDENCIA KORRESPONDENZ CORRESPONDENCE					
		<		>	
N°	TYPE TIP TYP	AGRICARB	ORIGINE	AGRICARB	ORIGINE
77	Pöttinger	BDP 5248	9791500700	BDP 5248	9791500700
78		SMP 0151		SMP 0151	
61	Quivogne	BDK 3090	SOC20002	BDK 3090	SOC20002
79		BDQ 2214		BDQ 2214	
17		SCH 0080A	SOC21301 SOC21322	SCH 0080A	SOC21301 SOC21322
18		SCH 0080B	SOC21301 SOC21322	SCH 0080B	SOC21301 SOC21322
12	SCH 0080C	SOC21322 SOC21301	SCH 0080C-R	SOC21322 SOC21301	
13	SCH 0080P	SOC301 SOC322	SCH 0080P-R	SOC301 SOC322	
3	SCH0080P-HY		SCH0080P-HY		
25	Rabewerk	BDG 8392		BDG 8392-R	
80		BDR 0310	GG210	BDR 0310	GG210
81		BDR 310V	GG41	BDR 310V	GG41
82	Razol	BDR 1667	021667 021842	BDR 1667	021667 021842
83		BDR 200V	3488	BDR 200V	3488
6	Souchu-Pinet	BDL 220V	10226	BDL 220V	10226

84 BDU0701



258	120	20	70		BTFCC1240
BDU0701					87,07
Kos					

BDU0701

88 BDV7618



240	50	20	/		BTFCC1280
BDV7618					60,84
Cultus, Swift					

BDV7618

1 BDU2065C



260	70	25	48		BTFCC1290
BDU2065C					73,53
Agromulch / Cross, Kos Premium					

BDU2065C

89 BDV8117



278	80	20	30		BTFCC1260
BDV8117					71,21
Cultus, Opus, Topdown					

BDV8117

85 SMV5996

NEW



346,7	50	32	28,6-96,8		
SMV5996					173,05
TopDown					

SMV5996

90 BDV8441



275	50	25	30		BTFCC1260
BDV8441					67,82
BDV8441-R					83,91
Cultus, Swift, Topdown, Opus					

BDV8441

86 BDV2854C



260	80	20	/		BTFCC1280
BDV2854C					92,77
BDV2854C-R					92,77
Cultus/Swift					

BDV2854C

91 BDV9233B



280	80	20	30		BTFCC1260
BDV9233B					68,18
Cultus, Swift, Topdown, Opus					

BDV9233B

87 BDV3698



425	50	20	58		BTFCC1270
BDV3698					65,10
Topdown					

BDV3698

92 BDV9233C



280	80	20	30		BTFCC1260
BDV9233C					73,53
Cultus, Swift, Topdown, Opus					

BDV9233C



93 BDV9233P Q



↕	↔	⤴	↻	⬡
293	90	42	30	BTFC1260
< >				€
BDV9233P				86,06
Cultus, Swift, Topdown, Opus				

BDV9233P 86,06

94 BDA8765-40 Q

NEW











↕	↔	⤴	↻	⬡
550	40	80	70	BTFC1280
< >				€
BDA8765-40				83,17
Cenius				

BDA8765-40 83,17

CORRESPONDANCE CORRESPONDENCIA KORRESPONDENZ CORRESPONDENCE					
			<	>	
N°	TYPE TIP TYP	AGRICARB	ORIGINE	AGRICARB	ORIGINE
84	Unia	BDU 0701	AP/701 245126	BDU 0701	AP/701 245126
1		BDU 2065C	AU/2065	BDU 2065C	AU/2065
85	Vaderstad	SMV 5996		SMV 5996	
86		BDV 2854C	452854	BDV 2854C-R	452854
87		BDV 3698	47369-1	BDV 3698	47369-1
88		BDV 7618	457618	BDV 7618	457618
89		BDV 8117	208117	BDV 8117	208117
90		BDV 8441	498382	BDV 8441-R	498382
91		BDV 9233B	155028 489233-1 498383	BDV 9233B	155028 489233-1 498383
92		BDV 9233C	155028 489233-1 498383	BDV 9233C	155028 489233-1 498383
93		BDV 9233P	155028 489233-1 498383	BDV 9233P	155028 489233-1 498383
94					
	BDA 8765-40		BDA 8765-40		

Notes
Nota | notiz | note







1 SOC203V  Type Double Cœur | Tipo corazón doble
| Typ Doppelherz | Type Double-Heart

				
420	100	20	45-80	BTFCC1280
				€
SOC203V				114,62



SOC203V







6 SCC7012-H  Profilées + Angles | Perfilados + Angulos
| Formstahl + Winkel | Pointed + Angles

				
330	110	15	45-80	BTFCC1260
				€
SCC7012-H				86,14



SCC7012-H







2 SOC213V 

				
420	100	20	45-80	BTFCC1480
				€
SOC213V				114,62



SOC213V







7 SCU3312  Profilées | Perfilados | Formstahl | Pointed

				
330	160	15	45-80	BTFCC1260
				€
SCU3312				113,67



SCU3312







3 ESCAL4114 

				
143	40	10	40-70	Ø 12 mm
				€
ESCAL4114				11,41



ESCAL4114

8 SCU3314  Profilées | Perfilados | Formstahl | Pointed







				
330	160	15	45-80	BTFCC1260
				€
SCU3314				113,67



SCU3314

SCU3314 = SCU3312 + ACTUB1412-22



4 SCC3312-H  Profilées + Angles | Perfilados + Angulos
| Formstahl + Winkel | Pointed + Angles

				
330	160	15	45-80	BTFCC1260
				€
SCC3312-H				113,67



SCC3312-H







9 SCU7012  Profilées | Perfilados | Formstahl | Pointed

				
330	110	15	45-80	BTFCC1260
				€
SCU7012				86,14



SCU7012

5 SCC3314-H  Profilées + Angles | Perfilados + Angulos
| Formstahl + Winkel | Pointed + Angles







				
330	160	15	45-80	BTFCC1260
				€
SCC3314-H				113,67



SCC3314-H

SCC3314-H = SCC3312-H + ACTUB1412-22

10 SCU9071 

				
465	160	41,5	45-75	BTFCC Ø12
				€
SCU9071				98,95



SCU9071



CORRESPONDANCE CORRESPONDENCIA KORRESPONDENZ CORRESPONDENCE					
		<		>	
N°	TYPE TIP TYP	AGRICARB	ORIGINE	AGRICARB	ORIGINE
1	Farmet	SOC 203V		SOC 203V	
2	Goizin	SOC 213V		SOC 213V	
1	Pöttinger	SOC 203V		SOC 203V	
1	Quivogne	SOC 203V		SOC 203V	
1	Sicam	SOC 203V		SOC 203V	
3	Universel- Universal	ESCAL 4114		ESCAL 4114	
4		SCC 3312-H		SCC 3312-H	
5		SCC 3314-H		SCC 3314-H	
6		SCC 7012-H		SCC 7012-H	
7		SCU 3312		SCU 3312	
8		SCU 3314		SCU 3314	
9		SCU 7012		SCU 7012	
10		SCU 9071		SCU 9071	

ACTUB1412-22

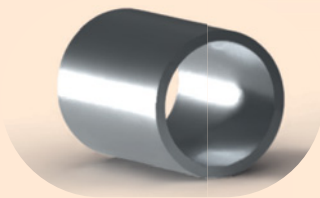

Entretoise ACTUB1412-22 :
permet de réduire le Ø diamètre du support de fixation de 14mm à 12mm pour montage pièce en Ø12 mm avec boulons Ø12mm

Steel pipe ACTUB1412-22 :
allows to reduce the Ø diameter of the mounting bracket from 14mm to 12mm for mounting Ø12mm wear parts with Ø12mm bolts.

Die Spannstiften ACTUB1412-22 :
Ermöglichen die Reduzierung des Bohrungs Ødurchmessers des zinkens von 14mm auf 12 mm um die montage von Ø12 mm verschleißteilen und Schrauben auf ein Ø12mm Zinken.

Espaciador ACTUB1412-22 :
permite reducir el diámetro Ø del soporte de montaje de 14mm a 12mm para el montaje de piezas de Ø12mm con tornillos de Ø12mm

Exemple sur un SCC3312-H
Example on SCC3312-H
Beispiel auf ein SCC3312-H
Ejemplo sobre un SCC3312-H

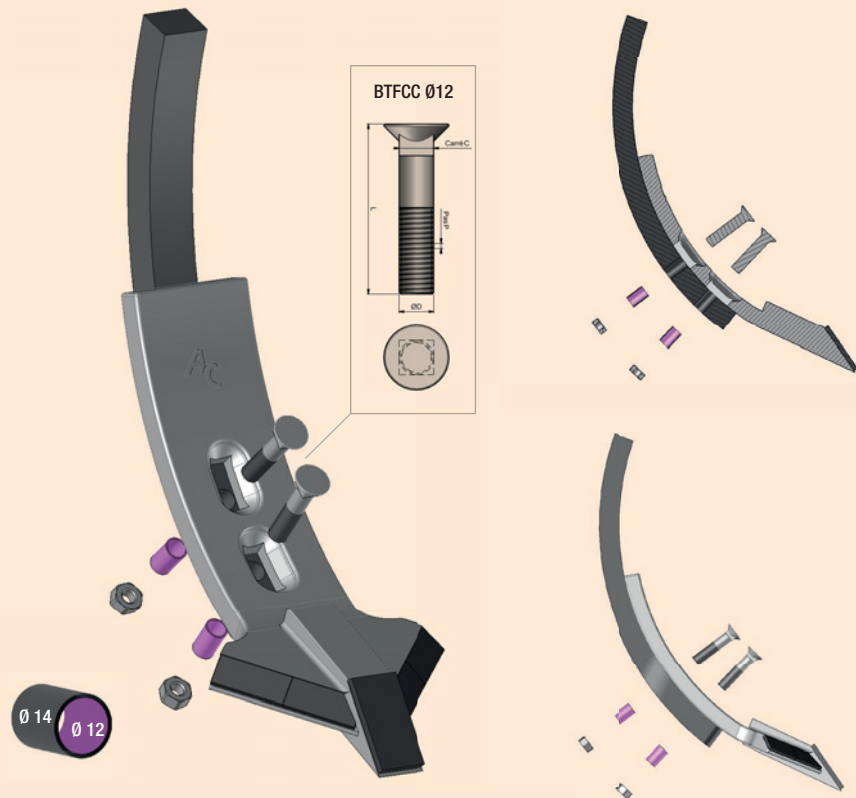



11 SOC0050 









				
360	50	20	40-85	BTFC1260
				
SOC0050				€ 52,59

SOC0050

16 SOC0202 









				
375	70	29	45-85	BTFC1280
				
SOC0202				€ 67,07

SOC0202

12 SOC0060 









				
360	60	20	45-85	BTFC1260
				
SOC0060				€ 53,63

SOC0060

17 SOC0203 









				
420	100	20	45-85	BTFC1280
				
SOC0203				€ 84,77

SOC0203

13 SOC0060-RV 









				
355	60	32,5	45-85	BTFC1260
				
SOC0060-RV				€ 86,82

SOC0060-RV

18 SOC0212 









				
380	70	20	45-85	BTFC1490
				
SOC0212				€ 67,07

SOC0212

14 SOC0060-XT 



				
355	60	27	45-85	BTFC1260
				
SOC0060-XT				€ 77,12

SOC0060-XT

19 SOC060A 









				
360	60	20	45-85	BTFC1260
				
SOC060A				€ 113,08

SOC060A

15 SOC0200  Toutes marques, vrillés | Todas marcas, barrenadas | Alle gewölbten, typen | All marks, curved









				
360	70	20	45-85	BTFC1260
				
SOC0200G		SOC0200D		€ 66,60

SOC0200G

20 SOC060F 



				
360	60	20	45-85	BTFC1260
				
SOC060FG		SOC060FD		€ 135,88

SOC060FG



1 SOC203V 🔍 Type Double Cœur | Tipo corazón doble
| Typ Doppelherz | Type Double-Heart

↕	↔	↗	↻	⊕
420	100	20	45-80	BTFC1280
< >				€
SOC203V				114,62

SOC203V

2 SOC213V 🔍

↕	↔	↗	↻	⊕
420	100	20	45-80	BTFC1480
< >				€
SOC213V				114,62

SOC213V

21 SOC4050 🔍

↕	↔	↗	↻	⊕
310	40	20	40-60	BTFC1260
< >				€
SOC4050				43,85

SOC4050

22 SOC6070-XT 🔍

↕	↔	↗	↻	⊕
360	60-70	28	45-85	BTFC Ø 12 mm
< >				€
SOC6070-XT				85,25

SOC6070-XT

23 SOC7080 🔍

↕	↔	↗	↻	⊕
345	70-80	23	45-85	BTFC1260
< >				€
SOC7080				88,29

SOC7080

CORRESPONDANCE CORRESPONDENCIA KORRESPONDENZ CORRESPONDENCE					
		<		>	
N°	TYPE TIP TYP	AGRICARB	ORIGINE	AGRICARB	ORIGINE
11		SOC 0050		SOC 0050	
12		SOC 0060		SOC 0060	
13		SOC 0060-RV		SOC 0060-RV	
14		SOC 0060-XT		SOC 0060-XT	
15		SOC 0200G		SOC 0200D	
16		SOC 0202		SOC 0202	
17		SOC 0203		SOC 0203	
18	Universal-Universal	SOC 0212		SOC 0212	
19		SOC 060A		SOC 060A	
20		SOC 060FG		SOC 060FD	
1		SOC 203V		SOC 203V	
2		SOC 213V		SOC 213V	
21		SOC 4050		SOC 4050	
22		SOC 6070-XT		SOC 6070-XT	
23		SOC 7080		SOC 7080	

SOC0060-XT

SOC0060-RV

1 ADA0301



210	12	49	BTHEX1270-OB	
ADA0301G	ADA0301D	86,45		

ADA0301G Agromulch Tine, Silver & Gold

6 ADU3214



300	12	45-75	BTFC1290	
ADU3214		131,83		

ADU3214 Rafale-Makila

2 ADH0856



200	12	60	BTHEX1270-OB	
ADH0856G	ADH0856D	84,33		

ADH0856G Puma / Terrano / Tiger / Versatill

7 ADL4460



195	12	55	BTHEX1290-OB	
ADL4460G	ADL4460D	90,81		

ADL4460G Onatar

3 ADA8679



170	12	65	BTHEX1270-OB	
ADA8679G	ADA8679D	86,45		

ADA8679G Cenius

8 ADD0450



280	14	47	BTF2E1235	
ADD0450G	ADD0450D	111,38		

ADD0450G

4 ADL360C



360	14	70	BTRCC1240-OB	
ADL360CG	ADL360CD	117,53		

ADL360CG Pegasus / Deltaflex / Smaragd / CTM

9 ADF3267

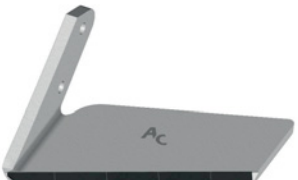

226	12	60	BTHEX1270	
ADF3267G	ADF3267D	86,45		

ADF3267G Duolent

5 ADB0447



262	12	65	Ø 12 mm	
ADB0447G	ADB0447D	95,42		

ADB0447G Fenix, terraland

10 ADQ5012



500	12	45-85	BTFC1290	
ADQ5012		240,20		

ADQ5012



11 ADS9708

	290	12	50	BTFC1040
				€
ADS9708G		ADS9708D		99,98

ADS9708D Polymag

12 ADQ5014

	500	12	45-85	BTFC1490
				€
ADQ5014				240,20

ADQ5014 Mixer

13 ADG0087

	254	12		
				€
ADG0087				162,58

ADG0087 Crossland DART

14 ADG0280

	280	15	/	Ø 12 mm
				€
ADG0280				138,44

ADG0280 Discodent

15 ADG0440

	440	12	/	Ø 12 mm
				€
ADG0440				204,62

ADG0440 Discodent / Helios

CORRESPONDANCE CORRESPONDENCIA KORRESPONDENZ CORRESPONDENCE					
		<		>	
N°	TYPE TIP TYP	AGRICARB	ORIGINE	AGRICARB	ORIGINE
1	Agrisem	ADA 0301G	216020302 1103627	ADA 0301D	216020301 1103626
2	Alpego	ADH 0856G	D16601G MKOA00279	ADH 0856D	D16601D MKOA00279
	Bremer	ADH 0856G		ADH 0856D	
3	Amazone	ADA 8679G	78708679 78708829	ADA 8679D	78708678 78708830
		ADL 360CG	XL005	ADL 360CD	XL004
5	Bednar	ADB 0447G	KM060447	ADB 0447D	KM060448
6	Bonnel	ADU 3214	13100043	ADU 3214	13100043
7	Carré	ADL 4460G	50316903	ADL 4460D	50316904
8	Doublet Record	ADD 0450G	0423400G	ADD 0450D	0423450D
9	Farnet	ADF 3267G	3003266 3002405	ADF 3267D	3003267 3002406
		ADQ 5012	GX460NS	ADQ 5012	GX460NS
11		ADS 9708G	3001161	ADS 9708D	3001161
12	Goizin	ADQ 5014	7002	ADQ 5014	7002
13		ADG 0087	M340087	ADG 0087	M340087
14	Grégoire-Besson	ADG 0280	107802500 107803700	ADG 0280	107802500 107803700
		ADG 0440	25100 29100	ADG 0440	25100 29100



16 ADH0854



125	12	60	BTHEX1270-OB	
				€
ADH0854G	ADH0854D	75,88		

ADH0854G
Terrano / Tiger

20 ADK0005



205	12	/	Ø 12 mm	
				€
ADK0005G	ADK0005D	80,11		

ADK0005G
Trio, Quadro, Vector

2 ADH0856



200	12	60	BTHEX1270-OB	
				€
ADH0856G	ADH0856D	84,33		

ADH0856G
Puma / Terrano / Tiger / Versatill

21 ADK6015



315	12	/	BTHEX1270-OB	
				€
ADK6015		141,38		

ADK6015
Trio, Quadro, Vector / Dracula, Terremoto

17 ADH0856-HY



215	12	60	BTHEX1280	
				€
ADH0856-HYG	ADH0856-HYD	89,47		

ADH0856-HYG
Terrano / Tiger

22 ADK6025



350	12	/	BTHEX1270-OB	
				€
ADK6025		148,48		

ADK6025
Trio, Quadro, Vector

18 ADH8883



240	12	60	Ø 12 mm	
				€
ADH8883G	ADH8883D	80,11		

ADH8883G
Terrano / Tiger, Deltacut

23 ADK6055



315	12	/	BTHEX1270-OB	
				€
ADK6055		141,38		

ADK6055
Trio, Quadro, Vector

19 ADH9058

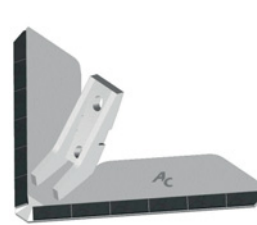

396	12	57	BTFC Ø 12 mm	
				€
ADH9058		190,91		

ADH9058
Terracut

4 ADL360C

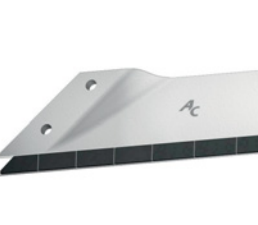

360	14	70	BTRCC1240-OB	
				€
ADL360CG	ADL360CD	117,53		

ADL360CG
Pegasus / Deltaflex / Smaragd / CTM



24 ADK7032

ADK7032G

↕	↔	↔	↔	⊕
267	10	70	BTHEX1270-OB	
<	>	€		
ADK7032G	ADK7032D	86,45		
 Deltaflex				

25 ADK8180

ADK8180G

↕	↔	↔	↔	⊕
238	12	65	BTHEX1270-OB	
<	>	€		
ADK8180G	ADK8180D	90,81		
 Cultimer				

12 ADQ5014

ADQ5014

↕	↔	↔	↔	⊕
500	12	45-85	BTFCC1490	
<	>	€		
ADQ5014		240,20		
 Mixer				

26 ADK0125

ADK0125G

↕	↔	↔	↔	⊕
390	12	75	BTFCC1240	
<	>	€		
ADK0125G	ADK0125D	107,20		

27 ADK1123

ADK1123

↕	↔	↔	↔	⊕
290	12	40 - 60	BTFCC1250- BTFCC1250- BTC1M1440-ES	
<	>	€		
ADK1123		128,94		
 CLC				

CORRESPONDANCE CORRESPONDENCIA KORRESPONDENZ CORRESPONDENCE					
		<		>	
N°	TYPE I TIP I TYP	AGRICARB	ORIGINE	AGRICARB	ORIGINE
16		ADH 0854G	34060855	ADH 0854D	34060854
2		ADH 0856G	34060856 310985 311274	ADH 0856D	34060857 310986 311275
17	Horsch	ADH 0856-HYG	34060856	ADH 0856-HYD	34060857
18		ADH 8883G	60038883	ADH 8883D	60038885
19		ADH 9058	60009058	ADH 9058	60009058
2	Ilgi	ADH 0856G		ADH 0856D	
2	Jean-de-Bru	ADH 0856G	02/1191206 02/1191216	ADH 0856D	02/1191205 02/1191215
20		ADK 0005G	506025 506015 932216	ADK 0005D	506015 506025 932214
21	Köckerling	ADK 6015	506015	ADK 6015	506015
22		ADK 6025	506025	ADK 6025	506025
23		ADK 6055	506055	ADK 6055	506055
4	Kongsilde-Howard	ADL 360CG	71209026469	ADL 360CG	71209026469
24	Kongsilde New Holland	ADK 7032G	7204027032 101003132	ADK 7032D	7204027031 101003131
25	Kuhn-Huard	ADK 8180G	H2218190G H2218191G	ADK 8180D	H2218180D H2218181D
12		ADQ 5014	622210	ADQ 5014	622210
26	Kverneland	ADK 0125G	131126	ADK 0125D	131125
27		ADK 1123	KK301123	ADK 1123	KK301123

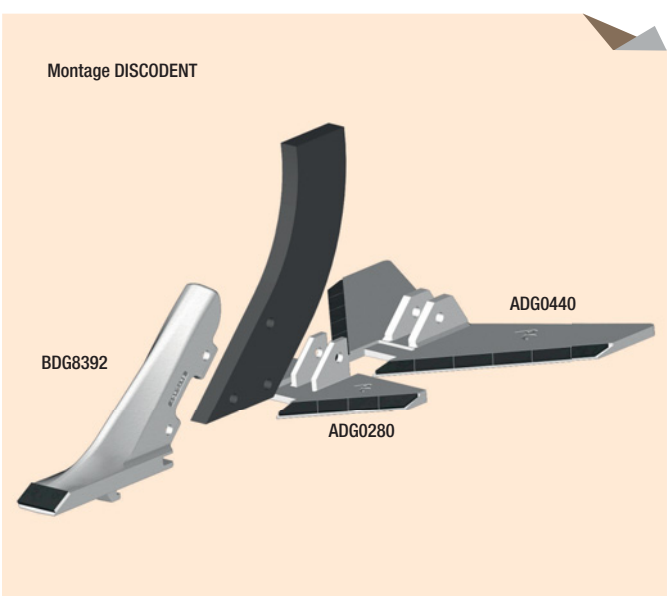

28 **ADK4701**



	345	12	91	BTHEX1680-200-EC
				€
ADK4701			148,48	

ADK4701 CLC

4 **ADL360C**



	360	14	70	BTRCC1240-OB
				€
ADL360CG		ADL360CD		117,53

ADL360CG Pegasus / Deltaflex / Smaragd / CTM

29 **ADK7186**



	187	12	91	BTHEX1680-200-EC
				€
ADK7186G		ADK7186D		ADK7186

ADK7186G CTC / Enduro

33 **ADL4428**



	250	14	70	BTRCC1240-OB
				€
ADL4428G		ADL4428D		84,24

ADL4428G Thorit

30 **ADL0018**

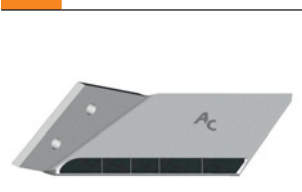

	195	12	55	BTHEX1290-OB
				€
ADL0018G		ADL0018D		89,47

ADL0018G Karat

7 **ADL4460**



	195	12	55	BTHEX1290-OB
				€
ADL4460G		ADL4460D		90,81

ADL4460G Onatar

31 **ADL0020**

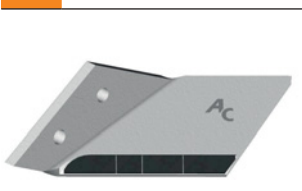

	160	12	55	BTHEX1290-OB
				€
ADL0020G		ADL0020D		82,98

ADL0020G Karat

34 **ADP0240**



	183	12	/	BTHEX1670-150-NYEM
				€
ADP0240D		ADP0240D		86,45

ADP0240D Synkro

32 **ADL0360**



	360	14	70	BTRCC1240-OB
				€
ADL0360G		ADL0360D		107,20

ADL0360G Smaragd / KOS

2 **ADH0856**

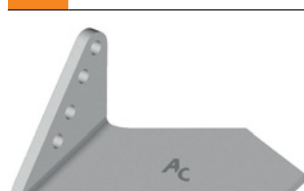

	200	12	60	BTHEX1270-OB
				€
ADH0856G		ADH0856D		84,33

ADH0856G Puma / Terrano / Tiger / Versatill



35 ADP0250



ADP0250G

↕	↔	↔	↔	⊕
300	12	/	BTHEX1670-150-NYEM	
<	>	€		
ADP0250G	ADP0250D	94,94		
⚙️				
Synkro				

36 ADP0300



ADP0300G

↕	↔	↔	↔	⊕
300	12	70	BTFCC1240	
<	>	€		
ADP0300G	ADP0300D	111,38		
⚙️				
Synkro				

16 ADH0854



ADH0854G

↕	↔	↔	↔	⊕
125	12	60	BTHEX1270-0B	
<	>	€		
ADH0854G	ADH0854D	75,88		
⚙️				
Terrano / Tiger				

37 ADQ4012



ADQ4012

↕	↔	↔	↔	⊕
400	12	45-85	BTFCC1280	
<	>	€		
ADQ4012		223,64		
⚙️				

10 ADQ5012



ADQ5012

↕	↔	↔	↔	⊕
500	12	45-85	BTFCC1290	
<	>	€		
ADQ5012		240,20		
⚙️				

CORRESPONDANCE | CORRESPONDENCIA | KORRESPONDENZ | CORRESPONDENCE

N°	TYPE TIP TYP	AGRICARB	ORIGINE	AGRICARB	ORIGINE
28	Kverneland	ADK 4701	A133204701	ADK 4701	A133204701
29		ADK 7186G	A135467286	ADK 7186D	A135467186
30	Lemken	ADL 0018G	33710019	ADL 0018D	33710018
31		ADL 0020G	33710021	ADL 0020D	33710020
32		ADL 0360G	33710021	ADL 0360D	3374416D
4		ADL 360CG	3374421G	ADL 360CD	3374420D 3374424D
33		ADL 4428G	3374429G	ADL 4428D	3374428D
7		ADL 4460G	3374461 3374463	ADL 4460D	3374460 3374462
21		Maschio	ADK 6015	R18025740R	ADK 6015
4	ADL 360CG		F20120020	ADL 360CD	F20120019
2	Ovlac	ADH 0856G		ADH 0856D	
34	Pöttinger	ADP 0240G	9762500230G	ADP 0240D	9762500240D
35		ADP 0250G	9781500200	ADP 0250D	9781500300
36		ADP 0300G	966500310 966500210	ADP 0300D	966500310 966500210
16	Quivogne	ADH 0854G	311180	ADH 0854D	311181
2		ADH 0856G	SOC21302 SOC21321	ADH 0856D	SOC21303 SOC21320
37		ADQ 4012		ADQ 4012	
10		ADQ 5012		ADQ 5012	
12		ADQ 5014		ADQ 5014	

12 ADQ5014

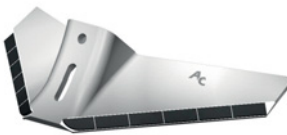









ADQ5014

↕	↔	↔	↔	⊕
500	12	45-85	BTFCC1490	
<	>	€		
ADQ5014		240,20		
⚙️				
Mixer				









38 **ADR0060** 





				
	315	12	60	BTFCC1040
				€
ADR0060G	ADR0060D	107,20		
				









32 **ADL0360** 





				
	360	14	70	BTRCC1240-OB
				€
ADL0360G	ADL0360D	107,20		
				









39 **ADR0075** 





				
	365	12	75	BTFCC1040
				€
ADR0075G	ADR0075D	109,21		
				









4 **ADL360C** 



				
	360	14	70	BTRCC1240-OB
				€
ADL360CG	ADL360CD	117,53		
				









40 **ADR0290** 





				
	300	12	50	BTFCC1240
				€
ADR0290G	ADR0290D	99,67		
				









37 **ADQ4012** 





				
	400	12	45-85	BTFCC1280
				€
ADQ4012			223,64	
				









6 **ADU3214** 





				
	300	12	45-75	BTFCC1290
				€
ADU3214			131,83	
				









41 **ADV5001** 



				
	200	12	57	BTFCC1280
				€
ADV5001G	ADV5001D	86,45		
				

11 **ADS9708** 











				
	290	12	50	BTFCC1040
				€
ADS9708G	ADS9708D	99,98		
				



CORRESPONDANCE CORRESPONDENCIA KORRESPONDENZ CORRESPONDENCE					
		<		>	
N°	TYPE TIP TYP	AGRICARB	ORIGINE	AGRICARB	ORIGINE
38	Rabewerk	ADR 0060G	GG45	ADR 0060D	GG45
39		ADR 0075G	GG51	ADR 0075D	GG51
40	Razol	ADR 0290G	003490	ADR 0290D	003489
6		ADU 3214		ADU 3214	
11	Rau Sicam	ADS 9708G	9708	ADS 9708D	9708
32	Religieux	ADL 0360G		ADL 0360D	
4	Souchu-Pinet	ADL 360CG	10228	ADL 360CD	10227
32	Unia	ADL 0360G	245128	ADL 0360D	245128
37	Universel- Universal	ADQ 4012		ADQ 4012	
10		ADQ 5012		ADQ 5012	
12		ADQ 5014		ADQ 5014	
6		ADU 3214		ADU 3214	
41	Väderstad	ADV 5001G	475001	ADV 5001D	475000
40	Vogel & Noot	ADR 0290G	CV04509G	ADR 0290D	CV04508D

1 STB0173M 











				
280	18	45	BTFCC1250	
		STB0173M		€
				117,45
				

STB0173M Swifter

6 STH6759 











				
228	8	45	BTFCC1270	
		STH6759		€
				120,27
				

STH6759 Finer

2 STC2560M 











				
265	190	19	40-45	BTFCC Ø 12 mm
		STC2560M		€
				85,40
				

STC2560M

7 STH7505 











				
298	303	12	57	BTFCC1260
		STH7505		€
				162,06
				

STH7505 Airseeder CO, Sprinter ST

3 STF0236M 











				
265	17	/	BTFCC1250	
		STF0236M		€
				117,45
				

STF0236M Kompaktomat

8 STK4032M  Ø12 : + ACTUB1210-22











				
200	20	45	BT- FCC1060-ECL	
		STK4032M		€
				85,40
				

STK4032M Allrounder

4 STH7505 





				
298	303	12	57	BTFCC1260
		STH7505		€
				162,06
				

STH7505 Crossland

9 STK4032M-12 











				
220	20	40-55	BTFCC Ø 12 mm	
		STK4032M-12		€
				85,40
				

STK4032M-12 Allrounder

5 STH1511M 











				
232	207	20	45	BTFCC1260
		STH1511M		€
				98,75
				

STH1511M Cruiser

10 STK7658M 



				
225	19	72	BTFCC Ø12	
		STK7658M		€
				111,86
				

STK7658M Vario



11 STK0584M



STK0584M

↕	↔	↗	↻	⊕
260	20	40-45	BTFCC1250	
<	>	€		
STK0584M			117,45	
 Vibroflex, Vibrotill				

12 STKU3170M



STKU3170M

↕	↔	↗	↻	⊕
205	18		BTFCC Ø12	
<	>	€		
STKU3170M			98,75	
 Prolander				

13 STKV0235M



STKV0235M

↕	↔	↗	↻	⊕
225	18	40	BTFCC Ø12	
<	>	€		
STKV0235M			117,45	
 Turbo				

14 STL0066

NEW



STL0066

↕	↔	↗	↻	⊕
350			BTFCC1270 BTFCC1240	
<	>	€		
STL0066			230,12	
 Karat, Kristall				

15 STL0080

NEW



STL0080

↕	↔	↗	↻	⊕
350				
<	>	€		
STL0080			251,06	
 Karat, Kristall, Koralin				

CORRESPONDANCE | CORRESPONDENCIA | KORRESPONDENZ | CORRESPONDENCE

		<		>	
N°	TYPE I TIP I TYP	AGRICARB	ORIGINE	AGRICARB	ORIGINE
1	Bednar	STB 0173M	KM060173	STB 0173M	KM060173
2	Case	STC 2560M	372560A1	STC 2560M	372560A1
3	Farmet	STF 0236M	3000236	STF 0236M	3000236
4	Grégoire-Besson	STH 7505		STH 7505	
5		STH 1511M	311408 311511	STH 1511M	311408 311511
6	Horsch	STH6759	60036759	STH6759	60036759
7		STH 7505	C1027505	STH 7505	C1027505
8		STK 4032M	504032	STK 4032M	504032
9	Köckerling	STK 4032M-12	504032	STK 4032M-12	504032
10		STK 7658M	937658	STK 7658M	937658
11	Kongskilde-Howard New Holland	STK 0584M	105000584	STK 0584M	105000584
12	Kuhn	STKU 3170M	H2243170	STKU 3170M	H2243170
13	Kverneland	STKV 0235M		STKV 0235M	
14		STL 0066	33710066	STL 0066	33710066
15	Lemken	STL 0080	33710080	STL 0080	33710080
16		STL 4356M	3374356	STL 4356M	3374356

16 STL4356M



STL4356M

↕	↔	↗	↻	⊕
255	17	/	BTFCC1050	
<	>	€		
STL4356M			117,45	
 Kompaktor				

17 STT0260

NEW



	260			
				€
STT0260			128,49	

STT0260 TR274

22 STU3812M



	380	20	40-65	BTFCC Ø 12 mm
				€
STU3812M			128,66	

STU3812M

18 STT0300

NEW



	300			
				€
STT0300			135,78	

STT0300

23 STV5038



	235	8	/	BTFCC Ø 12 mm
				€
STV5038			117,45	

STV5038 Swift

19 STU1810M



	185	20	45	BTFCC Ø10
				€
STU1810M			80,65	

STU1810M

20 STU2512M



	250	20	40-65	BTFCC Ø 12 mm
				€
STU2512M			102,70	

STU2512M

21 STU3012M



	300	20	40-65	BTFCC Ø 12 mm
				€
STU3012M			111,32	

STU3012M

CORRESPONDANCE CORRESPONDENCIA KORRESPONDENZ CORRESPONDENCE					
N°	TYPE I TIP I TYP	AGRICARB	ORIGINE	AGRICARB	ORIGINE
17	Treffler	STT 0260		STT 0260	
18		STT 0300	TR300 U11 8117347	STT 0300	TR300 U11 8117347
19	Universel- Universal	STU 1810M		STU 1810M	
20		STU 2512M		STU 2512M	
21		STU 3012M		STU 3012M	
22		STU 3812M		STU 3812M	
23	Väderstad	STV 5038	165038	STV 5038	165038



ACTUB1210-22

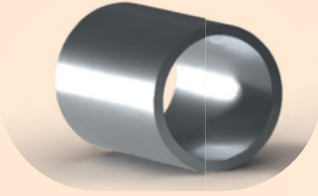

Entretoise ACTUB1210-22 :
permet de réduire le Ø diamètre du support de fixation de 12mm à 10mm pour montage pièce en Ø10mm avec boulons Ø10mm

Steel pipe ACTUB1210-22 :
allows to reduce the Ø diameter of the mounting bracket from 12mm to 10mm for mounting Ø10mm wear parts with Ø10mm bolts.

Die Spannstiften ACTUB1210-22 :
Ermöglichen die Reduzierung des Bohrungs Ø durchmessers des zinkens von 12mm auf 10 mm um die montage von Ø10 mm verschleißteilen und Schrauben auf ein Ø10mm Zinken.

Espaciador ACTUB1210-22 :
permite reducir el diámetro Ø del soporte de montaje de 12mm a 10mm para el montaje de piezas de Ø10mm con tornillos de Ø10mm

Exemple sur un STK4032M
Example on STK4032M
Beispiel auf ein STK4032M
Ejemplo sobre un STK4032M

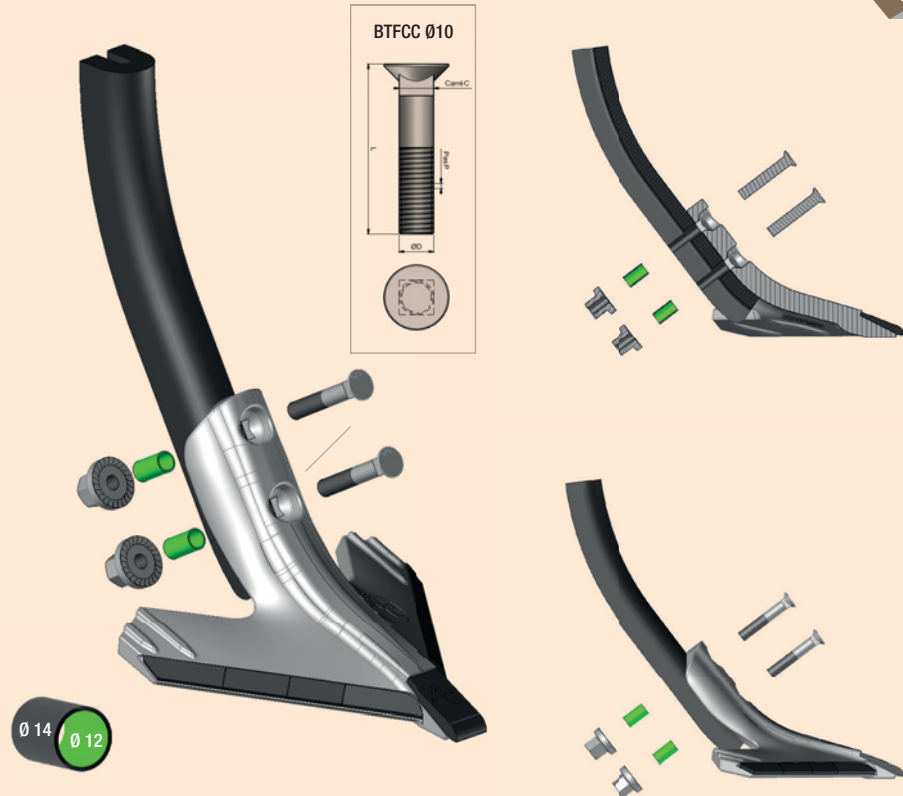

Prestation de soudage

Welding service / Umbau von Gänsefußschare / Prestación de soldadura

PSS T**

PSS T

↔	
PSST 1020 : 100 mm ≤ A 200 mm	
PSST 2030 : 200 mm ≤ A 300 mm	
PSST 3040 : 300 mm ≤ A 400 mm	
<	>
	€
PSST-1020	72,31
PSST-2030	86,02
PSST-3040	98,78
⚙️	

Retrouvez toutes nos prestations page 160 | Find out about all our services on page 160 | Informieren Sie sich über alle unsere Dienstleistungen auf Seite 160 | Descubra todos nuestros servicios en la página 160.

Sous-solage Subsoiling

Untergrundlockerung
Subsolador





▲ **Lames de décompacteurs** 44

Blades for heavy cultivation

Tiefenlockerermeißel

Piezas descompactador

▲ **Lames genre Duro, Durou, Agrisem** 46

Blades to fit Agrisem, Duro, Durou

Meißel passend für Agrisem, Duro, Durou

Piezas tipo Agrisem, Duro, Durou

▲ **Becs de décompacteurs plats et ailerons sabots sous-soleuse type Actisol** 50

Heavy cultivation point and wings.
Subsoiling shoes to fit Actisol

Spitzen – untergrundlockerung
tiefenlockerermeißel & flügelschare
Tiefenlockerermeißel passend für Actisol

Puntas descompactadores planas y alas
Botas de subsolador tipo Actisol

▲ **Sabots sous-soleuse** 56

Subsoiling shoes

Tiefenlockerermeißel

Botas de subsolador

80

1 BDS7050-S



BDS7050-S

410	65	40	50-80	BTG0800
				€
BDS7050-S		60,91		
BDS7050-RS		84,33		

85

8 BLR0085



BLR0085G

410	50	40	85	/
				€
BLR0085G		BLR0085D		251,17
ARAPLOW, ACB				

5 BLM7234



BLM7234G

370	70	25	80	BTFC1660-NY
				€
BLM7234G		BLM7234D		110,61
Helisol / Néolab / SSD2R / Combi-Digger / ACV / SSD				

9 CLR0085



CLR0085G

350	210	20	85	BTFC1440 Goupilles
				€
CLR0085G		CLR0085D		206,27

6 CLM0270



CLM0270G

400	340	30	80	BTFC1440 Goupilles
				€
CLM0270G		CLM0270D		206,27
Helisol / Contre-lame				

11 BLR6233



BLR6233G

335	60	25	85	BTFC1450
				€
BLR6233G		BLR6233D		110,61
Heliplow vigne / Profilab				

12 BLM6022



BLM6022G

400	60	20	80	BTG0800
				€
BLM6022G		BLM6022D		220,69
Combi-Digger				

90

2 BLA0090



BLA0090G

400	70	20	90	BTG0800
				€
BLA0090G	BLA0090D			251,17

Héliplow M320 113

3 BLG7236



BLG7236G

370	70	25	90	BTFC1660-NY
				€
BLG7236G	BLG7236D			110,61

Helios (SP/R), Heliplow LM, Discodent

4 CLA0090



CLA0090G

470	310	30	90	BTFHC1440 Goupilles
				€
CLA0090G	CLA0090D			224,39

Héliplow

10 BLG0117-S



BLG0117-S

410	65	40	90	
				€
BLG0117-S				160,97
BLG0117-RS				184,39

Heliplow, Helios

CORRESPONDANCE | CORRESPONDENCIA | KORRESPONDENZ | CORRESPONDENCE

		<		>	
N°	TYPE TIP TYP	AGRICARB	ORIGINE	AGRICARB	ORIGINE
1	Askel	BDS 7050-S		BDS 7050-RS	
2		BLA 0090G	M320113	BLA 0090D	M320113
3		BLG 7236G		BLG 7236D	
4		CLA 0090G	M310065 M310064	CLA 0090D	M310065 M310064
5	Bonnell	BLM 7234G	3707025	BLM 7234D	3707025
6		CLM 0270G		CLM 0270D	
5	Carré	BLM 7234G		BLM 7234D	
8	Gard	BLR 0085G		BLR 0085D	
9		CLR 0085G		CLR 0085D	
1	Grégoire-Besson	BDS 7050-S		BDS 7050-RS	
10		BLG 0117-RS	M320117	BLG 0117-RS	M320117
3		BLG 7236G	M320113 M320117	BLR 6233D	M320104
11		BLR 6233G	M320104	BLR 6233D	M320104
1	Lame Michel	BDS 7050-S		BDS 7050-RS	
12		BLM 6022G		BLM 6022D	
5		BLM 7234G		BLM 7234D	
6		CLM 0270G		CLM 0270D	
1	Quivogne	BDS 7050-S		BDS 7050-RS	
5		BLM 7234G		BLM 7234D	
6		CLM 0270G		CLM 0270D	
12	Rabe	BLM 6022G		BLM 6022D	
5		BLM 7234G		BLM 7234D	
9	Razol	BLR 0085G		BLR 0085D	
11		BLR 6233G		BLR 6233D	
6		CLM 0270G		CLM 0270D	
9		CLR 0085G		CLR 0085D	
11	Techmagri	BLR 6233G		BLR 6233D	
5	Vogel & Noot	BLM 7234G	SOC00037	BLM 7234D	SOC00037
6		CLM 0270G		CLM 0270D	

1 LAB0180



130	120	25	70	BTFHC1225
				€
LAB0180G	LAB0180D			69,58

LAB0180G

6 LAG1267



450	320	12	/	BTFHC2060
				€
LAG1267G	LAG1267D			341,60

LAG1267G

2 LAB5122



112	90	24	68,5	BTFHC1225
				€
LAB5122G	LAB5122D			67,48

LAB5122G

Agromulch, Cultiplow, Actimulch

7 LAG1267N



450	320	12	/	BTHEX2060-150-NY
				€
LAG1267NG	LAG1267ND			473,76

LAG1267NG

3 LAG1264



300	240	12	/	BTFHC2060
				€
LAG1264G	LAG1264D			447,49

LAG1264G

8 LAG1268



450	360	12	/	BTFHC2060
				€
LAG1268G	LAG1268D			484,54

LAG1268G

4 LAG1265



310	217	12	/	BTFHC1645-NY
				€
LAG1265G	LAG1265D			318,31

LAG1265G

9 VAGR0131

NEW

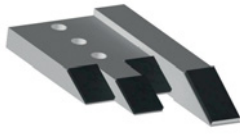

208	124	20	35	BTCHC1435
				€
VAGR0131G	VAGR0131D			201,18

VAGR0131G

Agromulch (classic, silver, gold) / Agroplow 18

5 LAG1265N



310	240	12	/	BTHEX1640-NY
				€
LAG1265NG	LAG1265ND			349,32

LAG1265NG

10 BDD3225



250	32	32	90	BTCHC1445
				€
BDD3225				67,25

BDD3225

11 BDD4325



BDD4325

255	40	30	90	BTCHC1445
				€
BDD4325				76,66

12 BDD7325



BDD7325

250	70	30	90	BTCHC1445
				€
BDD7325				98,87

13 LAB0510



LAB0510

290	100	35	100	BTFHC1225
				€
LAB0510				181,95

14 LAB0515



LAB0515

230	48	20	130	Goupille 8x20
				€
LAB0515				122,03

Strip-till

15 LDD3050

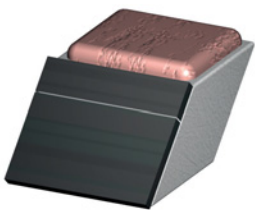

LDD3050

50	30	30	/	BTCHC1445
				€
LDD3050				56,73

CORRESPONDANCE CORRESPONDENCIA KORRESPONDENZ CORRESPONDENCE					
		<		>	
N°	TYPE TIP TYP	AGRICARB	ORIGINE	AGRICARB	ORIGINE
1		LAB 0180G	28132	LAB 0180D	28131
2		LAB 5122G	BOR15-121 BOR15-122 BOR15-28	LAB 5122D	BOR15-121 BOR15-122 BOR15-28
3		LAG 1264G	3604404	LAG 1264D	3604403
4		LAG 1265G	1510212	LAG 1265D	1510211
5	Agrisem	LAG 1265NG	TCS-SOC554W-MC	LAG 1265ND	TCS-SOC553W-MC
6		LAG 1267G	2012-332CBT	LAG 1267D	2012-331CBT
7		LAG 1267NG	653W-M1 658W	LAG 1267ND	654W-M1 658W
8		LAG 1268G	3204423G	LAG 1268D	3204424D
9		VAGR 0131G	SOC20-131-C1 SOC20-135	VAGR 0131D	SOC20-132-C1 SOC20-136
10		BDD 3225	Jallu	BDD 3225	Jallu
11		BDD 4325	1016a	BDD 4325	1016a
12		BDD 7325	1016a	BDD 7325	1016a
13		LAB 0510	3240510	LAB 0510	3240510
14		LAB 0515	STL0515 STL0007	LAB 0515	STL0515 STL0007
15		LDD 3050	1033	LDD 3050	1033

16 LDD4138



LDD4138

447	400	14	90-120	BTCHC1445- BTHEX1435- 150-NY
LDD4138			€	
			312,16	

17 LDD4139



LDD4139

407	250	14	90-120	BTCHC1445- BTHEX1435- 150-NY
LDD4139			€	
			224,20	

18 BLD0049



BLD0049G

Barre Lame Durou | Barra tipo
Lámina Durou | Splint für Meißel typ
Durou | Pin for Durou bar point-

400	70	20	100	BTFHC1440
BLD0049G		BLD0049D		€
				298,85

19 BLD0070



BLD0070G

400	70	20	100	BTFHC1440
BLD0070G		BLD0070D		€
				250,28

CORRESPONDANCE | CORRESPONDENCIA | KORRESPONDENZ | CORRESPONDENCE

N°	TYPE TIP TYP	AGRICARB	ORIGINE	AGRICARB	ORIGINE
16	Duro	LDD 4138	Jallu	LDD 4138	Jallu
17		LDD 4139	Jallu	LDD 4139	Jallu
18	Durou	BLD 0049G	LAM638	BLD 0049D	LAM638
19		BLD 0070G	LAM637	BLD 0070D	LAM637

Montage Lame Michel

Montaje Lame Michel | Montaje Lame Michel

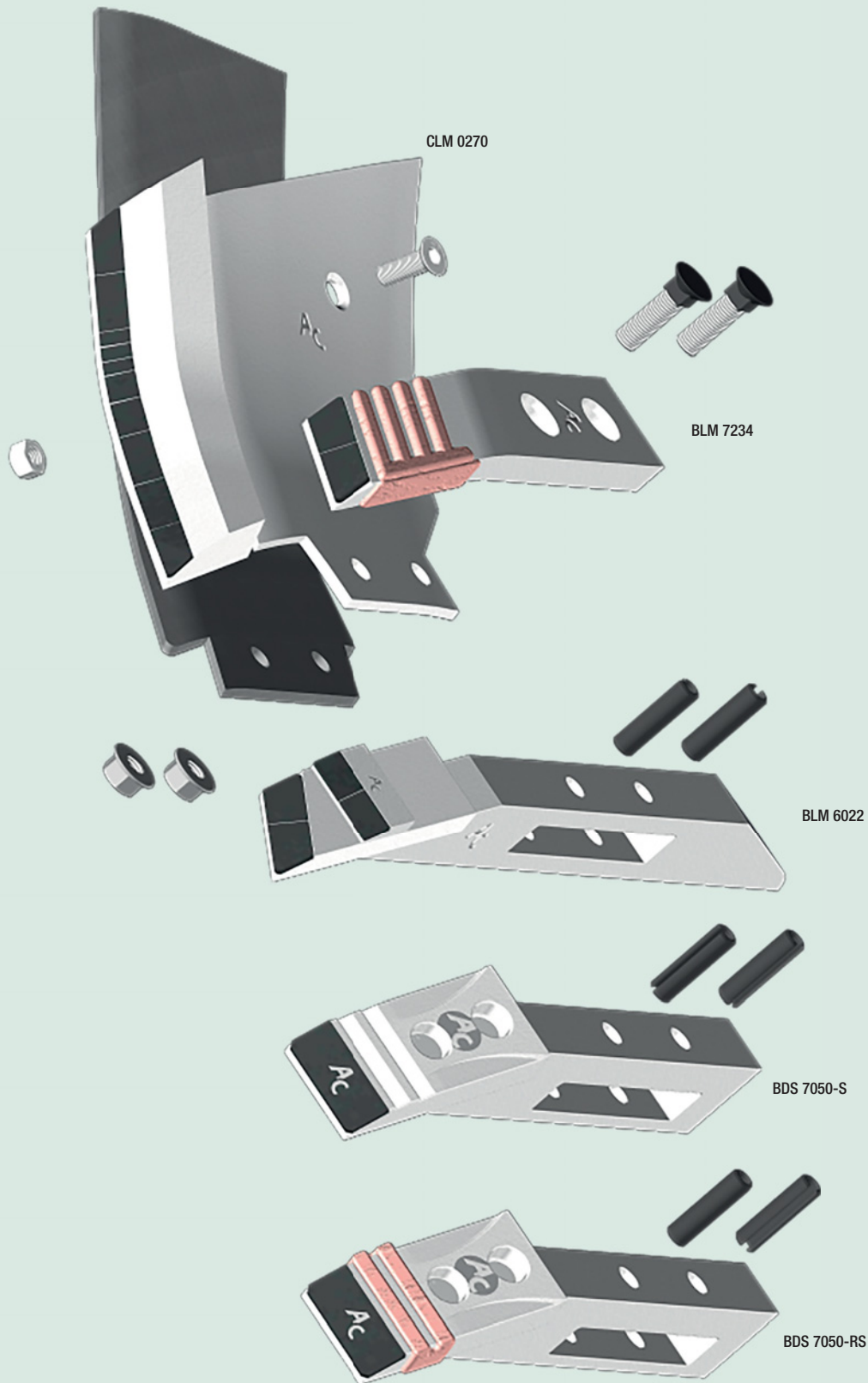

1 CMA4222



450	22	22	22	BTFHC1440
				€
CMA4222				53,53

CMA4222 B1

6 SFA9106



110	55	6	/	/
				€
SFA9106				104,38

SFA9106 B1

2 CMA4225



420	25	25	25	BTFHC1440
				€
CMA4225	CMA4225			61,25

CMA4225 B2, B3, Fissol

7 SFA9111



	400	10	55-65	Ø 12 mm
				€
SFA9111				213,11

SFA9111 B1

3 CMA4225-L

NEW



420	35	25	25	BTFHC1440
				€
CMA4225-L				86,64

CMA4225-L B2, B3, Fissol

8 SFA9113



	500	10	55-65	Ø 12 mm
				€
SFA9113				240,03

SFA9113 B1

4 CMA9325



146	60	15	/	/
				€
CMA9325				68,15

CMA9325

9 SFA9151



	230	10	55-65	Ø 12 mm
				€
SFA9151G	SFA9151D			129,56

SFA9151G B1

5 SFA9102



210	60	10	55-65	Ø 12 mm
				€
SFA9102				54,05

SFA9102 B1

10 SFA9206



194	56	6		Ø 14 mm
				€
SFA9206				104,38

SFA9206 B2

11 SFA9303



SFA9303

↕	↔	↔	↔	⊕
235	60	15	55-65	Ø 12mm
SFA9303				€
59,74				
B3				

12 SFA9304

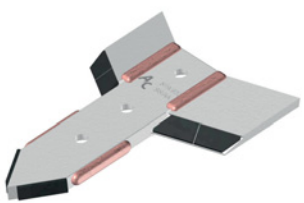

SFA9304

↕	↔	↔	↔	⊕
	180	15	55-65	Ø 12mm
SFA9304				€
128,35				
B3				

13 SFA9307

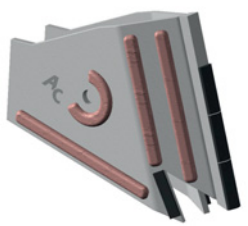

SFA9307

↕	↔	↔	↔	⊕
235	60	15	/	/
SFA9307				€
119,80				
B3				

14 SFA9311



SFA9311

↕	↔	↔	↔	⊕
	400	15	55-65	Ø 12mm
SFA9311				€
218,47				
B3				

15 SFA9312



SFA9312

↕	↔	↔	↔	⊕
	460	12	55-65	Ø 12 mm
SFA9312				€
230,37				
B3				

CORRESPONDANCE CORRESPONDENCIA KORRESPONDENZ CORRESPONDENCE					
		◀		▶	
N°	TYPE TIP TYP	AGRICARB	ORIGINE	AGRICARB	ORIGINE
1		CMA 4222	19100004 19100005	CMA 4222	19100004 19100005
2		CMA 4225	19200004 19200005B	CMA 4225	19200004 19200005B
3		CMA 4225-L	19200004 19200005B	CMA 4225-L	19200004 19200005B
4		CMA 9325	19300025 19300028	CMA 9325	19300025 19300028
5		SFA 9102	19100002 19200003	SFA 9102	19100002 19200003
6		SFA 9106	19100006 19100007	SFA 9106	19100006 19100007
7		SFA 9111	19100011 19100020	SFA 9111	19100011 19100020
8	Actisol	SFA9113	19100013	SFA9113	19100013
9		SFA 9151G	19100051	SFA 9151D	19100050
10		SFA 9206	19200006 19200007	SFA 9206	19200006 19200007
11		SFA 9303	19300003 19300002	SFA 9303	19300003 19300002
12		SFA 9304	19300004 19300039	SFA 9304	19300004 19300039
13		SFA 9307	19300007 19300006 19300017	SFA 9307	19300007 19300006 19300017
14		SFA 9311	19300011	SFA 9311	19300011
15		SFA9312	19300012	SFA9312	19300012



16 SFA9313



248	60	19	120	BTCAC1330
				€
SFA9313				59,73

SFA9313 FISSOL

21 ADA3310



325	300	14	100	BTFHC20120
				€
ADA3310				161,72

ADA3310 Cultichaum TL

17 SFA9317



126	55	58		
				€
SFA9317				79,81

SFA9317 FISSOL

22 ADA4810



600	385	14	100	BTFHC20120
				€
ADA4810				342,59

ADA4810 Cultichaum TL

18 SFA9318



381	40	55		Goupille 10x40
				€
SFA9318				149,67

SFA9318 FISSOL

23 BDA7055



345	70	30	55	Ø 16 mm
				€
BDA7055				99,98

BDA7055

19 SFA9321



168	55	5		
				€
SFA9321				81,91

SFA9321 FISSOL

24 BDA8055



345	80	30	55	Ø 18 mm
				€
BDA8055				107,20

BDA8055

20 SFA9339



248	182	27		BTCAC1330
				€
SFA9339				128,35

SFA9339 FISSOL

25 BDS7050-S



410	65	40	50-80	BTG0800
				€
BDS7050-S				60,91
BDS7050-RS				84,33

BDS7050-S

26 ADB0351



ADB0351G

↑↓	↔	↔	↔	⊕
146	195	12	55	Ø 14 mm
<	>	€		
ADB0351G		ADB0351D		79,43
 Terraland				

27 BDB0231



BDB0231

↑↓	↔	↔	↔	⊕
410	50	25	100	BTFCF Ø 12 mm
<	>	€		
BDB0231		110,61		
 Terraland, Terrastrap ZN				

28 BDB0070



BDB0070

↑↓	↔	↔	↔	⊕
300	100	30	70	BTCHC Ø 16mm
<	>	€		
BDB0070		98,29		
				

29 BDD0120



BDD0120

↑↓	↔	↔	↔	⊕
300	70	20	120	BTFCF Ø 16mm
<	>	€		
BDD0120		98,29		
				

30 LAB7069



LAB7069

↑↓	↔	↔	↔	⊕
365	53	30	334	BTCHC Ø12
<	>	€		
LAB7069		161,92		
 Biplo boulon, Interplo boulon, Biplo NSH, Interplo NSH				

CORRESPONDANCE CORRESPONDENCIA KORRESPONDENZ CORRESPONDENCE					
		<		>	
N°	TYPE TIP TYP	AGRICARB	ORIGINE	AGRICARB	ORIGINE
16		SFA9313	19310003 19310002	SFA9313	19310003 19310002
17		SFA 9317	19310007A 19310006C	SFA 9317	19310007A 19310006C
18	Actisol	SFA 9318	19310008	SFA 9318	19310008
19		SFA 9321	19310021	SFA 9321	19310021
20		SFA 9339	19310039A 19310004A	SFA 9339	19310039A 19310004A
21	Amazone	ADA 3310	6331010	ADA 3310	6331010
22		ADA 4810	6481010	ADA 4810	6481010
23		BDA 7055		BDA 7055	
24	Askel	BDA 8055		BDA 8055	
25		BDS 7050-S		BDS 7050-RS	
26	Bednar	ADB 0351G	KM060351	ADB 0351D	KM0604350
27		BDB 0231	KM060231	BDB 0231	KM060231
28	Bonnel	BDB 0070	20803	BDB 0070	20803
29		BDD 0120	4590	BDD 0120	4590
30	Demblon	LAB 7069	7069	LAB 7069	7069

31 LADE7036



LADE7036

↕	↔	✳	↻	⊕
460	290	12	120	Ø16
◀	▶	€		
LADE7036	LADE7036	250,01		

Biplo boulon, Interplo boulon, Biplo NSH, Interplo NSH

36 BDJ7050



BDJ7050

↕	↔	✳	↻	⊕
345	70	30	50	BTCHC Ø 10 mm
◀	▶	€		
BDJ7050				99,98

32 LDD1072

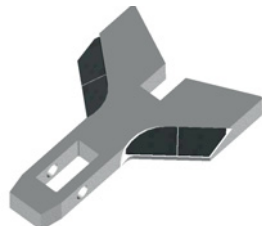

LDD1072

↕	↔	✳	↻	⊕
145	100	15		Goupille 5x30
◀	▶	€		
LDD1072				99,57

Strip-tilt

37 BLK0161



BLK0161G

↕	↔	✳	↻	⊕
310	60	15	75	
◀	▶	€		
BLK0161G	BLK0161D	85,85		

33 LDD1120



LDD1120

↕	↔	✳	↻	⊕
162	170	15		Goupille 5x30
◀	▶	€		
LDD1120				118,67

Strip-tilt

38 BDK0470



BDK0470

↕	↔	✳	↻	⊕
230	70	20	45	BTFHC1635
◀	▶	€		
BDK0470				76,11

Cultisoi

34 ADG01004

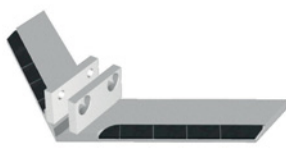

ADG01004

↕	↔	✳	↻	⊕
350	190	12	50	BTFCC10
◀	▶	€		
ADG01004				135,42

39 ADK1402



ADK1402G

↕	↔	✳	↻	⊕
310	120	12	55	BTFCC1240
◀	▶	€		
ADK1402G	ADK1402D	73,84		

35 BDS7050



BDS7050

↕	↔	✳	↻	⊕
160	70	25	50	BTFCC1250
◀	▶	€		
BDS7050				60,91
BDS7050-R				84,33

Hélios

40 BDK1320



BDK1320

↕	↔	✳	↻	⊕
345	70	30	55-65	BTFHC20120
◀	▶	€		
BDK1320				126,31

41 BDP6320-R

160x70x25

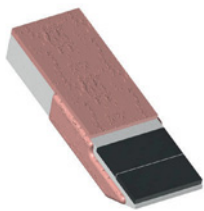

BDP6320-R

↕	↔	↗	↻	⊕
200	60	20	/	/
<			>	
BDP6320-R			113,08	

Charrue express

42 BDR8040

Q



BDR8040

↕	↔	↗	↻	⊕
360	80	30	40	Ø 14 mm
<			>	
BDR8040			107,22	



43 ADR4404

Q



ADR4404G

↕	↔	↗	↻	⊕
226	150	15	54	BTFC1240
<			>	
ADR4404G		ADR4404D		79,06

Aramulch

44 BDR4428

Q



BDR4428

↕	↔	↗	↻	⊕
400	60	30		
<			>	
BDR4428			141,45	

Aramulch

45 BDV0002

Q



BDV0002

↕	↔	↗	↻	⊕
485	70	25	65	BTFC Ø12
<			>	
BDV0002			111,61	

Terradig







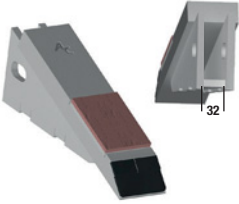

CORRESPONDANCE | CORRESPONDENCIA | KORRESPONDENZ | CORRESPONDENCE

		<		>	
N°	TYPE TIP TYP	AGRICARB	ORIGINE	AGRICARB	ORIGINE
31	Demblon	LADE 7036	7036	LADE 7036	7036
32	Duro	LDD 1072	STL1072	LDD 1072	STL1072
33		LDD 1120	STL1120	LDD 1120	STL1120
34	Goizin	ADGO 1004	701004	ADGO 1004	701004
35	Grégoire-Besson	BDS 7050	M320126 SD13549 SOC00040	BDS 7050-R	M320126 SD13549 SOC00040
36	Jaulent	BDJ 7050		BDJ 7050	
37	Kongkilde, Howard	BLK 0161G	73000HF0162	BLK 0161D	73000HF0161
38	Kuhn-Huard	BDK 0470	K18000470 52047600	BDK 0470	K18000470 52047600
39	Kverneland	ADK 1402G	217001402L	ADK 1402D	217001402R
40		BDK 1320	217001320 AGROMAT	BDK 1320	217001320 AGROMAT
35	Lame Michel	BDS 7050		BDS 7050-R	
41	Perrein	BDP 6320-R		BDP 6320-R	
35	Quivogne	BDS 7050	STD SCD	BDS 7050-R	STD SCD
42	Rau	BDR 8040	217001321	BDR 8040	217001321
43	Razol	ADR 4404G	14537 14404	ADR 4404D	14536 14403
44		BDR 4428	14534 14428	BDR 4428	14534 14428
45	Vogel & Noot	BDV 0002	U8610002	BDV 0002	U8610002





1 SDAG7032-R  Encastrement : 32











				
335	70	30	/	Ø 19 mm
				€
SDAG7032-R				119,35
				

SDAG7032-R SJ

6 SDA5610-R 









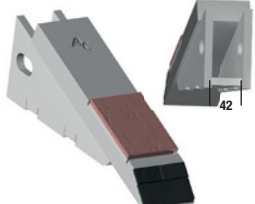

				
350	70	29	/	Ø 14 mm
				€
SDA5610-R				147,45
				

SDA5610-R Super craker

2 SDAG7042-R  Encastrement : 42











				
345	70	30	/	Ø 19 mm
				€
SDAG7042-R				119,35
				

SDAG7042-R SJ

7 SDA6080-R 









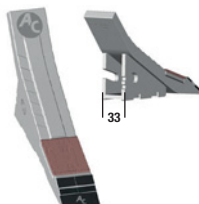

				
435	70	29	/	Ø 14 mm
				€
SDA6080-R				147,45
				

SDA6080-R Skat K1, Cracker KD/KE

3 SDA0433-R  Encastrement : 38









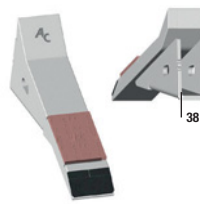

				
435	70	35		
				€
SDA0433-R				147,45
				

SDA0433-R Dent Cracker

8 SDA8378-R 









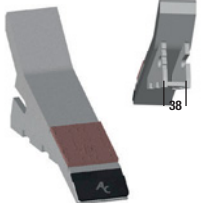

				
350	70	25	/	/
				€
SDA8378-R				134,63
				

SDA8378-R

4 SDA0445-R  Encastrement : 38











				
346	70	25		
				€
SDA0445-R				134,63
				

SDA0445-R Dent Roccia

9 SDA1368 









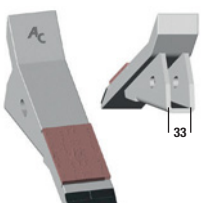

				
249	78	50		Ø 20 mm
				€
SDA1368				119,80
				

SDA1368 Cultichaum

5 SDA4625-R 











				
435	70	25	/	/
				€
SDA4625-R				134,63
				

SDA4625-R

10 SDB0171-R 



				
435	70	29	/	/
				€
SDB0171-R				147,45
				

SDB0171-R Terraland, TN-D, TN-HD, TN-PROFI

11 SDB0197-R



SDB0197-R

435	70	29	/	/
				€
SDB0197-R				147,45
Terraland, TN-M, TN-HM, TN-RT, TO				

12 SDC0070-R

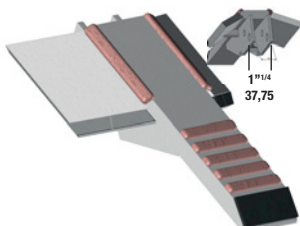

SDC0070-R

317	178	30	/	/
				€
SDC0070-R				180,15
ECOLOTIGER				

13 SDC0071-R

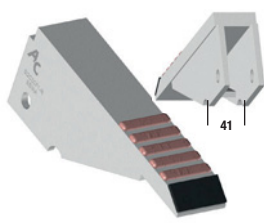

SDC0071-R

300	60	30	/	/
				€
SDC0071-R				151,82
ECOLOTIGER				

14 SDC0072-R

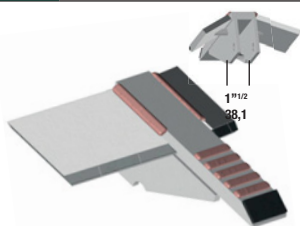

SDC0072-R

300	254	30	/	/
				€
SDC0072-R				212,55
ECOLOTIGER				

15 SDC0074-R

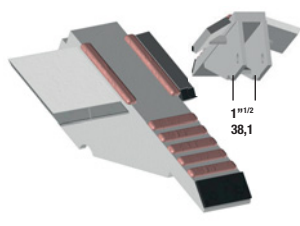

SDC0074-R

317	178	30	/	/
				€
SDC0074-R				180,15
ECOLOTIGER				

CORRESPONDANCE | CORRESPONDENCIA | KORRESPONDENZ | CORRESPONDENCE

		<		>		
N°	TYPE TIP TYP	AGRICARB	ORIGINE	AGRICARB	ORIGINE	
1	Agric-Jympa	SDAG 7032-R		SDAG 7032-R		
2		SDAG 7042-R		SDAG 7042-R		
3	Alpego	SDA 0433-R	MK0A00433 MK0A00464 MK0A00461	SDA 0433-R	MK0A00433 MK0A00464 MK0A00461	
4		SDA0445-R	MK0A00445	SDA0445-R	MK0A00445	
5		SDA 4625-R	E08462S	SDA 4625-R	E08462S	
6		SDA 5610-R	E05610 K2N5-250 MK0A00358 K27-300 / K29-400	SDA 5610-R	E05610 K2N5-250 MK0A00358 K27-300 / K29-400	
7		SDA 6080-R	E06080	SDA 6080-R	E06080	
8		SDA 8378-R	E08378S	SDA 8378-R	E08378S	
9		Amazone	SDA 1368	951368	SDA 1368	951368
10		Bednar	SDB 0171-R	KM060171 KM060431	SDB 0171-R	KM060171 KM060431
11	SDB 0197-R		KM060197 K2N5-250 KM060414	SDB 0197-R	KM060197 K2N5-250 KM060414	
12	Case	SDC 0070-R	87460070/7» (178mm)	SDC 0070-R	87460070/7» (178mm)	
13		SDC 0071-R	87460071/7»	SDC 0071-R	87460071/7»	
14		SDC 0072-R	87460072/10» (254mm)	SDC 0072-R	87460072/10» (254mm)	
15		SDC 0074-R	87460074/7» (178mm)	SDC 0074-R	87460074/7» (178mm)	
16		SDC 0075-R	87450075/2»	SDC 0075-R	87450075/2»	

16 SDC0075-R

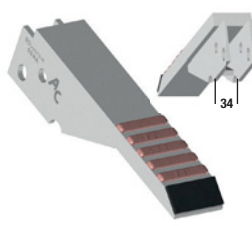

SDC0075-R

317	60	20	/	/
				€
SDC0075-R				180,15
ECOLOTIGER				

17 SDGA0040-R

Encastrement : 43

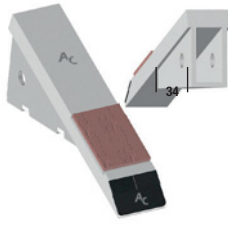

SDGA0040-R

350	70	30		
				€
SDGA0040-R				147,45

22 SDK0650



SDK0650

	258	50	40	
				€
SDK0650				130,08

Striger

18 SDG7336-R

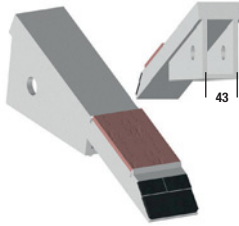

SDG7336-R

360	70	30	/	/
				€
SDG7336-R				147,45

23 SDL0113-R

Encastrement : 60x30

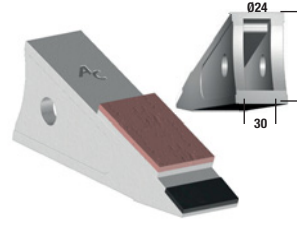

SDL0113-R

260	60	0	/	/
				€
SDL0113-R				127,60

Lelyroc

19 SDJ1020-R

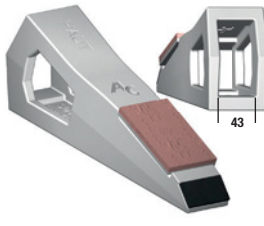

SDJ1020-R

330	70	116	/	/
				€
SDJ1020-R				204,45

24 SDL3005-R

Encastrement : 70x34



SDL3005-R

260	70	0	/	/
				€
SDL3005-R				127,60

Lely V

20 SDK0130

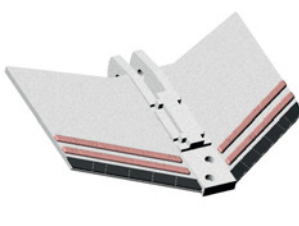

SDK0130

	450	74	45	
				€
SDK0130				397,10

Cultisoil, DC

25 SDM0270-R

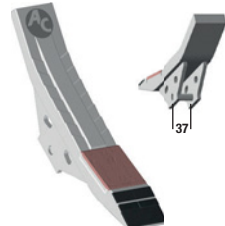

SDM0270-R

	440	70	25	/
				€
SDM0270-R				147,45

21 SDK0290

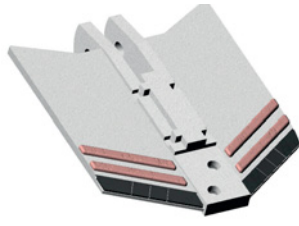

SDK0290

	280	58	45	
				€
SDK0290				345,59

Cultisoil, DC

26 SDM0370-R



SDM0370-R

	435	70	29	/
				€
SDM0370-R				147,45

27 **SDM0681-R**

435	70	29	/	/
				€
SDM0681-R				134,63

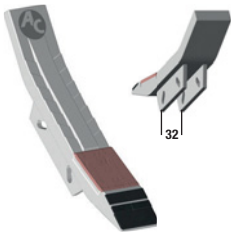

SDM0681-R

28 **SDM2661-R**

435	70	29	/	/
				€
SDM2661-R				134,63

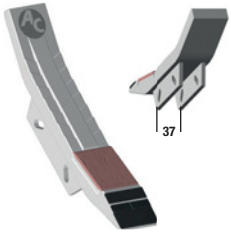

SDM2661-R

29 **SDQ0022-AR**

Encastrement : 70x35

265	240	/	/	/
				€
SDQ0022-AR				288,50

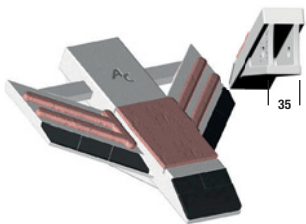

SDQ0022-R

30 **SDQ0022-R**

Encastrement : 70x35

265	70	/	/	/
				€
SDQ0022-R				134,63



SDQ0022-R

31 **SDQ2070-R**

Encastrement : 35

435	70	90	/	/
				€
SDQ2070-R				147,45



SDQ2070-R

CORRESPONDANCE | CORRESPONDENCIA | KORRESPONDENZ | CORRESPONDENCE

		<		>	
N°	TYPE TIP TYP	AGRICARB	ORIGINE	AGRICARB	ORIGINE
17	Gardell	SDGA 0040-R	Dent 40	SDGA 0040-R	Dent 40
18	Gascon	SDG 7336-R	850108392	SDG 7336-R	850108392
19	Jean-de-Bru	SDJ 1020-R	02/0171020	SDJ 1020-R	02/0171020
20		SDK 0130	K1800130	SDK 0130	K1800130
21	Kuhn	SDK 0290	K1800290	SDK 0290	K1800290
22		SDK 0650	K3020650	SDK 0650	K3020650
23	Lely	SDL 0113-R	Lelyroc	SDL 0113-R	Lelyroc
24		SDL 3005-R	LelyV	SDL 3005-R	LelyV
25	Maschio	SDM 0270-R	R17220270R R17622990R R17622960R	SDM 0270-R	R17220270R R17622990R R17622960R
26		SDM 0370-R	R17220370R R17623000R R17622960R	SDM 0370-R	R17220370R R17623000R R17622960R
27		SDM 0681-R	R17820681 R17820731	SDM 0681-R	R17820681 R17820731
28		SDM 2661-R	R17820661 R17820721	SDM 2661-R	R17820661 R17820721
29	Quivogne	SDQ 0022-AR	SOC00034	SDQ 0022-AR	SOC00034
30		SDQ 0022-R	SOC00022	SDQ 0022-R	SOC00022
31		SDQ 2070-R	VRR2070	SDQ 2070-R	VRR2070
32		SDQ 2080-R	VRR2080	SDQ 2080-R	VRR2080

32 **SDQ2080-R**

Encastrement : 40

435	70	110	/	/
				€
SDQ2080-R				147,45

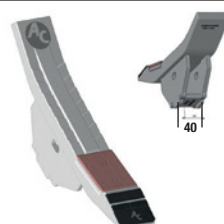

SDQ2080-R

33 **SDL3005-R**



SDL3005-R

Encastrement : 70x34

↕	↔	↗↖	↻	⬡			
260	70	0	/	/			
<table border="1"> <tr> <td>◀</td> <td>▶</td> <td>€</td> </tr> </table>				◀	▶	€	
◀	▶	€					
SDL3005-R				127,60			
⚙️							

38 **ADS0392**



ADS0392

↕	↔	↗↖	↻	⬡			
270	255	12	/	Ø 16 mm			
<table border="1"> <tr> <td>◀</td> <td>▶</td> <td>€</td> </tr> </table>				◀	▶	€	
◀	▶	€					
ADS0392				141,38			
⚙️							

34 **SDR4438-AR**

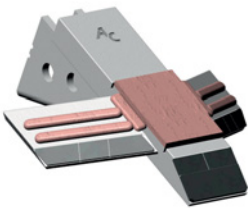

SDR4438-AR

Encastrement : 108x32

↕	↔	↗↖	↻	⬡			
305	255	30	/	/			
<table border="1"> <tr> <td>◀</td> <td>▶</td> <td>€</td> </tr> </table>				◀	▶	€	
◀	▶	€					
SDR4438-AR				301,32			
⚙️							

39 **SDS9148-R**



SDS9148-R

Encastrement : 21

↕	↔	↗↖	↻	⬡			
250	36	0	/	/			
<table border="1"> <tr> <td>◀</td> <td>▶</td> <td>€</td> </tr> </table>				◀	▶	€	
◀	▶	€					
SDS9148-R				70,94			
⚙️							

35 **SDR4438-R**

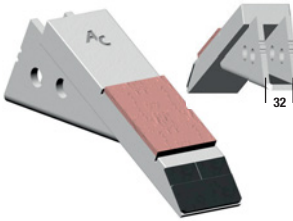

SDR4438-R

Encastrement : 108x32

↕	↔	↗↖	↻	⬡			
305	70	30	/	/			
<table border="1"> <tr> <td>◀</td> <td>▶</td> <td>€</td> </tr> </table>				◀	▶	€	
◀	▶	€					
SDR4438-R				134,63			
⚙️							

40 **SDU3530-R**

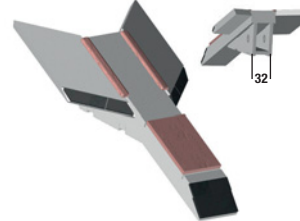

SDU3530-R

Encastrement : 32

↕	↔	↗↖	↻	⬡			
398	60	35	/	/			
<table border="1"> <tr> <td>◀</td> <td>▶</td> <td>€</td> </tr> </table>				◀	▶	€	
◀	▶	€					
SDU3530-R				220,78			
⚙️							

Kret

36 **SDR4529-AR**

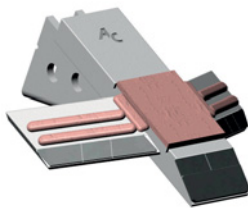

SDR4529-AR

Encastrement : 108x27

↕	↔	↗↖	↻	⬡			
305	255	30	/	/			
<table border="1"> <tr> <td>◀</td> <td>▶</td> <td>€</td> </tr> </table>				◀	▶	€	
◀	▶	€					
SDR4529-AR				301,32			
⚙️							

37 **SDR4529-R**

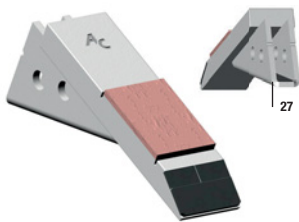

SDR4529-R

Encastrement : 108x27

↕	↔	↗↖	↻	⬡			
305	70	30	/	/			
<table border="1"> <tr> <td>◀</td> <td>▶</td> <td>€</td> </tr> </table>				◀	▶	€	
◀	▶	€					
SDR4529-R				134,63			
⚙️							

CORRESPONDANCE CORRESPONDENCIA KORRESPONDENZ CORRESPONDENCE					
		<		>	
Nº	TYPE TIP TYP	AGRICARB	ORIGINE	AGRICARB	ORIGINE
33	Rau-Sicam	SDL 3005-R	RF06515 RF05959	SDL 3005-R	RF06515 RF05959
34	Razol	SDR 4438-AR	AVR004823	SDR 4438-AR	AVR004823
35		SDR 4438-R	AVR004438	SDR 4438-R	AVR004438
36		SDR 4529-AR	AVS004529 AVS004822	SDR 4529-AR	AVS004529 AVS004822
37		SDR 4529-R	AVS004529	SDR 4529-R	AVS004529
38		Simba	ADS 0392	P10392	ADS 0392
39	SDS 9148-R		P09148	SDS 9148-R	P09148
	Tulip	SDS 9148-R		SDS 9148-R	
40	Unia	SDU 3530-R	1435/30-200/0	SDU 3530-R	1435/30-200/0
29	Vogel & Noot	SDQ 0022-AR	SOC00034	SDQ 0022-AR	SOC00034
30		SDQ 0022-R	SOC00022	SDQ 0022-R	SOC00022



Notes
Nota | notiz | note

Labour Ploughing

Pflügen
Laboreo



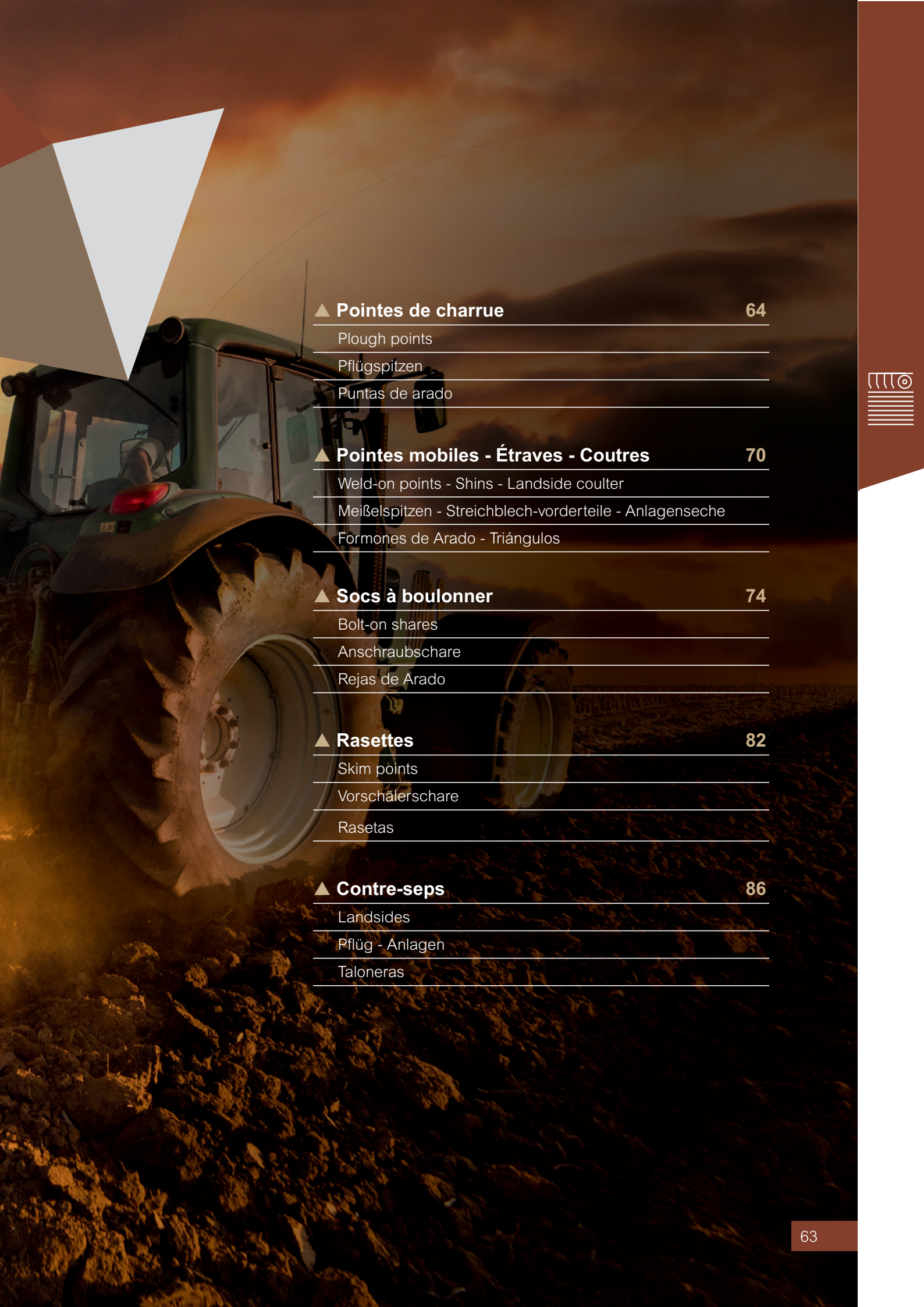

▲ **Pointes de charrue** **64**

Plough points

Pflügspitzen

Puntas de arado

▲ **Pointes mobiles - Étraves - Coutres** **70**

Weld-on points - Shins - Landside coulter

Meißelspitzen - Streichblech-vorderteile - Anlagenseche

Formones de Arado - Triángulos

▲ **Socs à boulonner** **74**

Bolt-on shares

Anschraubschare

Rejas de Arado

▲ **Rasettes** **82**

Skim points

Vorschälerschare

Rasetas

▲ **Contre-seps** **86**

Landsides

Pflüg - Anlagen

Talonerias



1 PBA0677



↕	↔	↔	↔	⊙	<	>	€
390	150	20	82	BTFC012	PBA0677G	PBA0677D	96,32
					PBA0677-RG	PBA0677-RD	113,45
					PBA0677-HRG	PBA0677-RD	142,65

2 PBB0074



↕	↔	↔	↔	⊙	<	>	€
260	70	20	50	BTFC01240	PBB0074G	PBB0074D	60,00
					PBB0074-RG	PBB0074-RD	80,15

3 PBB1710



↕	↔	↔	↔	⊙	<	>	€
240	70	20	50	BTFC01040	PBB1710		60,00
					PBA0677-R		80,15

4 PBB1712



↕	↔	↔	↔	⊙	<	>	€
240	70	20	50	BTFC01240	PBB1712		60,00
					PBB1712-R		80,15

5 PBB5256

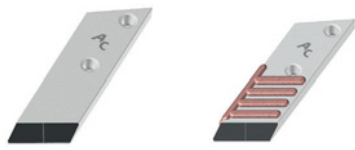

↕	↔	↔	↔	⊙	<	>	€
280	70	20	90	BTC2M1239	PBB5256G	PBB5256D	61,98
					PBB5256-RG	PBB5256-RD	79,99

6 PBD0025

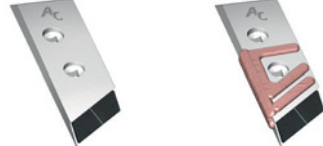

↕	↔	↔	↔	⊙	<	>	€
240	70	20	60	BTFC01240	PBD0025G	PBD0025D	60,00
				BTFC01250	PBD0025-RG	PBD0025-RD	80,15

7 PBD025L

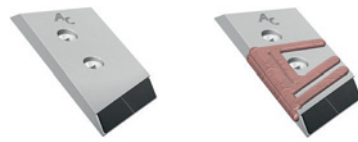

↕	↔	↔	↔	⊙	<	>	€
240	100	20	60	BTFC01240	PBD025LG	PBD025LD	81,07
				BTFC01250	PBD025L-RG	PBD025L-RD	99,56

8 PBD025LP

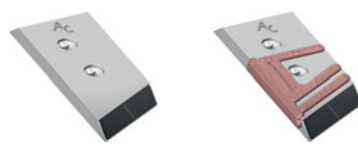

↕	↔	↔	↔	⊙	<	>	€
240	100	20	60	BTFC01240	PBD025LPG	PBD025LPD	81,07
				BTFC01250	PBD025LP-RG	PBD025LP-RD	99,56

9 PBD025P



↕	↔	↔	↔	⊙	<	>	€
240	70	20	60	BTFC01240	PBD025PG	PBD025PD	44,92
				BTFC01250	PBD025P-RG	PBD025P-RD	64,82

10 PBD2580P



↕	↔	↔	↔	⊙	<	>	€
240	80	20	60	BTFC01240	PBD2580PG	PBD2580PD	55,89
				BTFC01250	PBD2580P-RG	PBD2580P-RD	75,26

16 PBG0023



							€
↕	↔	↔	↔	⊕	◀	▶	
240	70	20	50	BTC2M1250	PBG0023G	PBG0023D	39,52
					PBG0023-RG	PBG0023-RD	60,97
					PBG0023-HRG	PBG0023-HRD	80,51

21 PBH0029



							€
↕	↔	↔	↔	⊕	◀	▶	
230	70	20	52	BTC2M1239	PBH0029G	PBH0029D	39,52
					PBH0029-RG	PBH0029-RD	60,97
					PBH0029-HRG	PBH0029-HRD	80,51

17 PBF0020

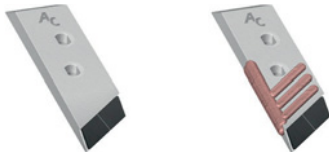

							€
↕	↔	↔	↔	⊕	◀	▶	
240	70	20	51	BTC2M1239	PBF0020G	PBF0020D	60,00
					PBF0020-RG	PBF0020-RD	80,15

22 PBH2128



							€
↕	↔	↔	↔	⊕	◀	▶	
230	76	30	52	BTC2M1239	PBH2128G	PBH2128D	51,66

18 PBG2385



							€
↕	↔	↔	↔	⊕	◀	▶	
243	85	20	50	BTC2M1239	PBG2385G	PBG2385D	52,08
					PBG2385-RG	PBG2385-RD	71,46

23 PBK5309



							€
↕	↔	↔	↔	⊕	◀	▶	
245	75	30	40	BTC2M1239	PBK5309G	PBK5309D	51,66

19 PBG7328



							€
↕	↔	↔	↔	⊕	◀	▶	
245	75	20	50	BTC2M1250	PBG7328G	PBG7328D	51,66

24 PBK9085

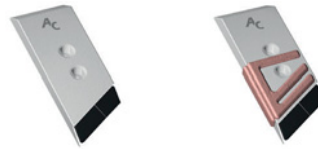

							€
↕	↔	↔	↔	⊕	◀	▶	
243	85	20	40	BTC2M1239	PBK9085G	PBK9085D	52,08
					PBK9085-RG	PBK9085-RD	71,46

20 PBI0018

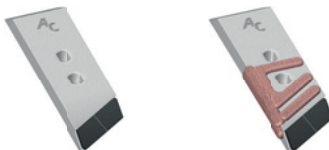

							€
↕	↔	↔	↔	⊕	◀	▶	
240	70	20	40	BTC2M1239	PBI0018G	PBI0018D	60,00
					PBI0018-RG	PBI0018-RD	80,15

25 PBS0188



							€
↕	↔	↔	↔	⊕	◀	▶	
240	70	20	40	BTC2M1239	PBS0188G	PBS0188D	39,52
					PBS0188-RG	PBS0188-RD	60,97
					PBS0188-HRG	PBS0188-HRD	80,51

26 PBL4054



↕	↔	↗	↘	⊕	◀	▶	€
345	100	20	85	BTFC1240	PBL4054G	PBL4054D	79,47
					PBL4054-RG	PBL4054-RD	100,83
					PBL4054-HRG	PBL4054-HRD	129,58

27 PBL4054N



↕	↔	↗	↘	⊕	◀	▶	€
345	100	20	85	BTFC1240	PBL4054NG	PBL4054ND	79,47
					PBL4054N-RG	PBL4054N-RD	100,83
					PBL4054N-HRG	PBL4054N-HRD	129,58

28 PBL4156N



↕	↔	↗	↘	⊕	◀	▶	€
345	100	20	85	BTFC1240	PBL4156NG	PBL4156ND	89,05
					PBL4156N-RG	PBL4156N-RD	108,53
					PBL4156N-HRG	PBL4156N-HRD	139,47

29 PBN0095



↕	↔	↗	↘	⊕	◀	▶	€
230	70	20	90	BT2E1440	PBN0095G	PBN0095D	41,32
					PBN0095-RG	PBN0095-RD	62,19
					PBN0095-HRG	PBN0095-HRD	80,51

30 PBN095L

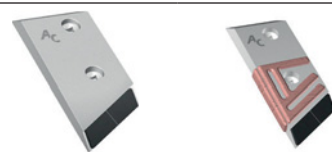

↕	↔	↗	↘	⊕	◀	▶	€
250	85	20	90	BTFC1440	PBN095LG	PBN095LD	81,07
					PBN095L-RG	PBN095L-RD	100,83

CORRESPONDANCE | CORRESPONDENCIA | KORRESPONDENZ | CORRESPONDENCE

N°	TYPE TIP TYP	◀		▶	
		AGRICARB	ORIGINE	AGRICARB	ORIGINE
16	Farnet	PBG 0023G		PBG 0023D	
		PBG 0023-RG		PBG 0023-RD	
17	Fenet	PBF 0020G	010900107	PBF 0020D	010900104
		PBF 0020-RG	010900107	PBF 0020-RD	010900104
16	Goizin	PBG 0023G	010154G	PBG 0023D	010104D
		PBG 0023-RG	010154G	PBG 0023-RD	010104D
18	Grégoire-Besson	PBG 2385G		PBG 2385D	
		PBG 2385-RG		PBG 2385-RD	
16	Grégoire-Besson	PBG 0023G	173464G 173332G 173342G	PBG 0023D	173463D 173331D 173341D
		PBG 0023-RG	173464G 173332G 173342G	PBG 0023-RD	173463D 173331D 173341D
14	Grégoire-Besson	PBG 0023-HRG	173464G 173332G 173342G	PBG 0023-HRD	173463D 173331D 173341D
		PBG 0024G		PBG 0024D	
18	Grégoire-Besson	PBG 0024-RG		PBG 0024D	
		PBG 2385G		PBG 2385D	
19	Grégoire-Besson	PBG 2385-RG		PBG 2385-RD	
		PBG 7328G	173464	PBG 7328D	173463
20	IH	PBI 0018G	1867673 6035	PBI 0018D	1867672 6034
		PBI 0018-RG	1867673 6035	PBI 0018-RD	1867672 6034
21	Kuhn-Huard	PBH 0029G	622129G 622175G 622165G	PBH 0029D	622128D 622174D 622164D
		PBH 0029-RG	622129G 622175G 622165G	PBH 0029-RD	622128D 622174D 622164D
22	Kuhn-Huard	PBH 0029-HRG	622129G 622175G 622165G	PBH 0029-HRD	622128D 622174D 622164D
		PBH 2128G	622129G 622175G 622165G	PBH 2128D	622128D 622174D 622164D
23	Kverneland	PBK 5309G	63090	PBK 5309D	53090
		PBK 9085G		PBK 9085D	
24	Kverneland	PBK 9085-RG		PBK 9085-RD	
		PBS 0188G	63090	PBS 0188D	53090
25	Kverneland	PBS 0188-RG	63090	PBS 0188-RD	53090
		PBS 0188-HRG	63090	PBS 0188-HRD	53090
26	Lemken	PBL 4054G	3364055 3364051	PBL 4054D	3364054 3364050
		PBL 4054-RG	3364055 3364051	PBL 4054-RD	3364054 3364050
27	Lemken	PBL 4054-HRG	3364055 3364051	PBL 4054-HRD	3364054 3364050
		PBL 4054NG	3364055 3364051 3364155	PBL 4054ND	3364054 3364050 3364154
28	Lemken	PBL 4054N-RG	3364055 3364051 3364155	PBL 4054N-RD	3364054 3364050 3364154
		PBL 4054N-HRG	3364055 3364051 3364155	PBL 4054N-HRD	3364054 3364050 3364154
26	Maschio	PBL 4156NG	3364157	PBL 4156ND	3364156
		PBL 4156N-RG	3364157	PBL 4156N-RD	3364156
27	Maschio	PBL 4156N-HRG	3364157	PBL 4156N-HRD	3364156
		PBL 4054G	(Siro)	PBL 4054D	(Siro)
29	Naud	PBL 4054-RG	(Siro)	PBL 4054-RD	(Siro)
		PBL 4054-HRG	(Siro)	PBL 4054-HRD	(Siro)
27	Maschio	PBL 4054NG	(Siro)	PBL 4054ND	(Siro)
		PBL 4054N-RG	(Siro)	PBL 4054N-RD	(Siro)
30	Naud	PBL 4054N-HRG	(Siro)	PBL 4054N-HRD	(Siro)
		PBN 0095G	031235G	PBN 0095D	031235D
29	Naud	PBN 0095-RG	031235G	PBN 0095-RD	031235D
		PBN 0095-HRG	031235G	PBN 0095-HRD	031235D
30	Naud	PBN 095LG	031235G	PBN 095LD	031235D
		PBN 095L-RG	031235G	PBN 095L-RD	031235D

31 PB00120

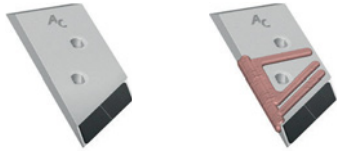

PB00120G					PB00120-RG		
↕	↔	↔	↔	⊕	◀	▶	€
240	100	20	65	BTC2M1250	PB00120G	PB00120D	81,07
					PB00120-RG	PB00120-RD	100,83

36 PBR0350

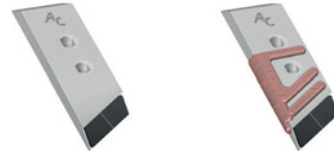

PBR0350G					PBR0350-RG		
↕	↔	↔	↔	⊕	◀	▶	€
240	70	20	45	BTC2M1245-OB	PBR0350G	PBR0350D	60,00
					PBR0350-RG	PBR0350-RD	80,15

32 PB00131



PB00131G					PB00131-RG		
↕	↔	↔	↔	⊕	◀	▶	€
240	100	20	50	BTC2M1250	PB00131G	PB00131D	81,07
					PB00131-RG	PB00131-RD	100,83

37 PBS0090



PBS0090G					PBS0090-RG		
↕	↔	↔	↔	⊕	◀	▶	€
330	100	20	85	BTFC1240	PBS0090G	PBS0090D	101,54
					PBS0090-RG	PBS0090-RD	118,77

33 PB00809



PB00809G					PB00809-RG		
↕	↔	↔	↔	⊕	◀	▶	€
317	100	20	50	BTFC1235	PB00809G	PB00809D	81,07
					PB00809-RG	PB00809-RD	100,83

38 PBG0023



PBG0023G					PBG0023-RG		PBG0023-HRG	
↕	↔	↔	↔	⊕	◀	▶	€	
240	70	20	50	BTC2M1250	PBG0023G	PBG0023D	39,52	
					PBG0023-RG	PBG0023-RD	60,97	
					PBG0023-HRG	PBG0023-HRD	80,51	

34 PBP0010



PBP0010G					PBP0010-RG		
↕	↔	↔	↔	⊕	◀	▶	€
240	100	20	100	BTC2M1239	PBP0010G	PBP0010D	81,07
					PBP0010-RG	PBP0010-RD	100,83

39 PBR0102



PBR0102G					PBR0102-RG		PBR0102-HRG	
↕	↔	↔	↔	⊕	◀	▶	€	
230	70	20	45	BTC2M1239	PBR0102G	PBR0102D	44,92	
					PBR0102-RG	PBR0102-RD	66,09	
					PBR0102-HRG	PBR0102-HRD	80,51	

35 PBP0210

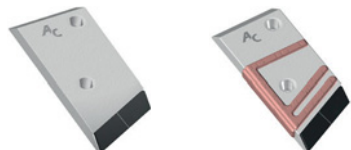

PBP0210G					PBP0210-RG		
↕	↔	↔	↔	⊕	◀	▶	€
240	100	20	110	BTC2M1239	PBP0210G	PBP0210D	81,07
					PBP0210-RG	PBP0210-RD	100,83

40 PBG0023



PBG0023G					PBG0023-RG		PBG0023-HRG	
↕	↔	↔	↔	⊕	◀	▶	€	
240	70	20	50	BTC2M1250	PBG0023G	PBG0023D	39,52	
					PBG0023-RG	PBG0023-RD	60,97	
					PBG0023-HRG	PBG0023-HRD	80,51	

41 PBG023P



PBG023PG

PBG023P-RG

↕	↔	↔	↻	⊕	◀	▶	€
240	70	20	50	BTC2M1239	PBG023PG	PBG023PD	60,00
					PBG023P-RG	PBG023P-RD	80,15

Choisissez votre rechargement

Choose your hardfacing | Wählen sie Hartauftrage | Elija su refuerzo



HR2
**RECHARGEMENT
 AU CARBURE DE
 TUNGSTÈNE**
 TUNGSTEN CARBIDE HARFACING |
 HARTAUFRAG VON
 HARTMETALL | REFUERZO CON CARBURO
 DE TUNGSTENO



**RECHARGEMENT
 AU CHROME**
 CHROMIUM HARFACING | CHROM
 HARTAUFRAG | REFUERZO CON CROMO



SANS RECHARGEMENT
 WITHOUT HARFACING | OHNE HARTAUFRAG | SIN REFUERZO

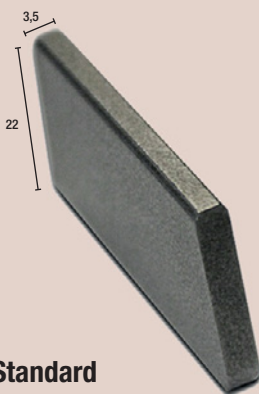

Standard

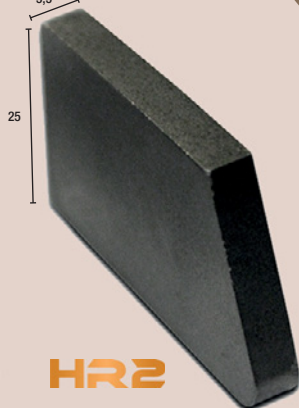







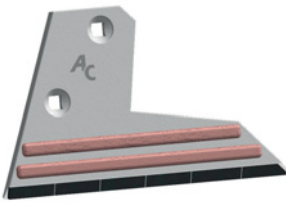

HR2

CORRESPONDANCE CORRESPONDENCIA KORRESPONDENZ CORRESPONDENCE					
N°	TYPE TIP TYP	◀		▶	
		AGRICARB	ORIGINE	AGRICARB	ORIGINE
26	Opall Agri	PBL 4054G	40411-04112	PBL 4054-HRD	40411-04220
		PBL 4054-RG	40411-04112	PBL 4054-RD	40411-04220
		PBL 4054-HRG	40411-04112	PBL 4054-HRD	40411-04220
27	Opall Agri	PBL 4054NG	(Siro)	PBL 4054ND	40411-04220
		PBL 4054N-RG	40411-04112	PBL 4054N-RD	40411-04220
		PBL 4054N-HRG	40411-04112	PBL 4054N-HRD	40411-04220
31	Overum-New Holland	PBO 0120G	85143G	PBO 0120D	84060D
		PBO 0120-RG	85143G	PBO 0120-RD	84060D
		PBO 0131G	94609G	PBO 0131D	94608D
32	Overum-New Holland	PBO 0131-RG	94609G	PBO 0131-RD	94608D
		PBO 0809G	1659460909	PBO 0809D	1659460809
		PBO 0809-RG	1659460909	PBO 0809-RD	1659460809
20	Ovlac	PBI 0018G	G64000330	PBI 0018D	G64000330
		PBI 0018-RG	G64000330	PBI 0018-RD	G64000330
16	Ovlac	PBG 0023G	9300211250G	PBG 0023D	930201250D
		PBG 0023-RG	9300211250G	PBG 0023-RD	930201250D
		PBG 0023-HRG	9300211250G	PBG 0023-HRD	930201250D
15	Ovlac	PBG 2385G	930211260G	PBG 2385D	930201260D
		PBG 2385-RG	930211260G	PBG 2385-RD	930201260D
		PBK 5309G	6763090	PBK 5309D	6753090
23	Pöttinger	PBK 9085G		PBK 9085D	
		PBK 9085-RG		PBK 9085-RD	
		PBP 0010G	925130210G	PBP 0010D	925130110D
34	Pöttinger	PBP 0010-RG	925130210G	PBP 0010-RD	925260110D
		PBP 0210G	925260210G	PBP 0210D	925260110D
		PBP0210-RG	925260210G	PBP0210-RD	925260110D
25	Pöttinger	PBS 0188G	6763090	PBS 0188D	6753090
		PBS 0188-RG	6763090	PBS 0188-RD	6753090
		PBS 0188-HRG	6763090	PBS 0188-HRD	6753090
12	Rabewerk	PBR 0102G	MP332	PBR 0102D	MP332
		PBR 0102-RG	MP332	PBR 0102-RD	MP332
		PBR 0102-HRG	MP332	PBR 0102-HRD	MP332
36	Rabewerk	PBR 0350G	MP350 MP293	PBR 0350D	MP350 MP293
		PBR 0350-RG	MP350 MP293	PBR 0350-RD	MP350 MP293
		PBK 5309G	1189	PBK 5309D	1188
24	Souchu-Pinet	PBK 9085G		PBK 9085D	
		PBK 9085-RG		PBK 9085-RD	
		PBS 0188G	1189	PBS 0188D	1188
25	Souchu-Pinet	PBS 0188-RG	1189	PBS 0188-RD	1188
		PBS 0188-HRG	1189	PBS 0188-HRD	1188
		PBS 0090G	A90PL	PBS 0090D	A90PR
37	Steno	PBS 0090-RG	A90PL	PBS 0090-RD	A90PR
		PBG 0023G	9300211250G	PBG 0023D	260191D 260301D
		PBG 0023-RG	260192G 260302G	PBG 0023-RD	260191D 260301D
38	Thieme	PBG 0023-HRG	260192G 260302G	PBG 0023-HRD	260191D 260301D
		PBR 0102G	1153152-G 1150172-G	PBR 0102D	1153151-D 1150171-D
		PBR 0102-RG	1153152-G 1150172-G	PBR 0102-RD	1153151-D 1150171-D
39	Unia	PBR 0102-HRG	1153152-G 1150172-G	PBR 0102-HRD	1153151-D 1150171-D
		PBG 0023G	PK0801102G	PBG 0023D	PK0801101D
		PBG 0023-RG	PK0801102G	PBG 0023-RD	PK0801101D
40	Vogel & Noot	PBG 0023-HRG	PK0801102G	PBG 0023-HRD	PK0801101D
		PBG 023PG	701401	PBG 023PD	701401 601401 801401
		PBG 023P-RG	701401	PBG 023P-RD	701401

1 **COU0227** 











				
287	169	12	80	BTFCC1235
				
COU0227G		COU0227D		81,73

COU0227G

6 **PMG0035** 



				
575	35	35	/	/
				
PMG0035		120,57		

PMG0035

2 **ETG3461** 

NEW











				
393	129	12	240	BTF2E1235
				
ETG3461G		ETG3461D		121,10

ETG3461G E8HL

7 **ETH0038** 











				
320	115	12	205	BTF2E1235
				
ETH0038G		ETH0038D		121,10

ETH0038G

3 **ETG0473** 











				
400	128	14	235	BTF2E1235
				
ETG0473G		ETG0473D		121,10

ETG0473G

8 **ETH0064** 











				
290	195	12	150	BTF2E1235
				
ETH0064G		ETH0064D		121,10

ETH0064G

4 **ETG2323** 











				
270	45	14	/	/
				
ETG2323G		ETG2323D		121,10

ETG2323G

9 **ETH0120** 











				
285	280	12	155-90	BTF2E1235
				
ETH0120G		ETH0120D		121,10

ETH0120G

5 **PMG0030** 











				
570	30	30	/	/
				
PMG0030		118,28		

PMG0030

10 **ETH0172** 











				
340	285	12	90-125-120	BTF2E1235
				
ETH0172G		ETH0172D		121,10

ETH0172G

11 ETH1780 



ETH1780G









				
295	195	12	145	BTF2E1235
				
ETH1780G		ETH1780D		121,11

12 ETH7220 

NEW











ETH7220G

				
308	266	12	94-98-98	BTF2E1235
				
ETH7220G		ETH7220D		121,10

13 ETK0250 











ETK0250G

				
275	160	12	145	BTF2E1235
				
ETK0250G		ETK0250D		117,49

14 ETK3230 



ETK3230G

				
340	163	12	147-96	BTF2E1235
				
ETK3230G		ETK3230D		121,10

15 COLE2890 



COLE2890G









				
235	95	6	100	BTFCC1045
				
COLE2890G		COLE2890D		72,76

CORRESPONDANCE CORRESPONDENCIA KORRESPONDENZ CORRESPONDENCE					
					
N°	TYPE TIP TYP	AGRICARB	ORIGINE	AGRICARB	ORIGINE
1	Demblon	COU 0227G	0227D 0227G	COU 0227D	0227D 0227G
2	Gregoire-Besson	ETG 3461G	173461	ETG 3461D	173462
3		ETG 0473G	173473 173475	ETG 0473D	173474 173476
4		ETG 2323G	172323	ETG 2323D	172324
5		PMG 0030	171207 172208	PMG 0030	171207 172208
6		PMG 0035	172330 172345	PMG 0035	172330 172345
7	Kuhn-Huard	ETH 0038G	619039	ETH 0038D	619038
8		ETH 0064G	619065	ETH 0064D	619064
9		ETH 0120G	619121 619169	ETH 0120D	619120 619168
10		ETH 0172G	619173	ETH 0172D	619172
11		ETH 1780G	619201 H0401790	ETH 1780D	619200 H0401780
12		ETH 7220G	H0407230 H0406770	ETH 7220D	H0407220 H0406760
13	Kverneland	ETK 0250G	073251	ETK 0250D	073250
14		ETK 3230G	073231	ETK 3230D	073230
15	Lemken	COLE 2890G	3492890	COLE 2890D	3492890

16 ETL1031 

NEW











				
359	269	10		BTFCC1240
				
ETL1031G		ETL1031D		121,10

ETL1031G Juwel

17 ETL3450 









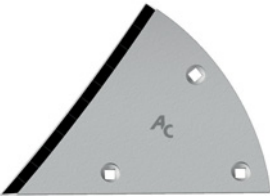

				
285	235	12	160-165	BTFCC1040
				
ETL3450G		ETL3450D		123,96

ETL3450G

18 ETL3454 











				
290	270	12	228-140	BTFCC1040
				
ETL3454G		ETL3454D		123,96

ETL3454G

19 PMV5325 



				
530	25	25	/	/
				
PMV5325				73,38

PMV5325

CORRESPONDANCE | CORRESPONDENCIA | KORRESPONDENZ | CORRESPONDENCE

		<		>	
N°	TYPE I TIP I TYP	AGRICARB	ORIGINE	AGRICARB	ORIGINE
16		ETL 1031G	3451031	ETL 1031D	3451030
17	Lemken	ETL 3450G	3451001 3451003	ETL 3450D	3451000 3451002
18		ETL 3454G	3451005 34510009	ETL 3454D	3451004 34510008
17	Opall Agri	ETL 3450G	40411-04-047	ETL 3450D	40411-04-046
19	Universel-Universal	PMV 5325		PMV 5325	











Notes

Nota | notiz | note

A series of horizontal dotted lines spanning the width of the page, intended for writing notes.

1 SBA0679 









				
488	143	15	135	BTFC012
				€
SBA0679G	SBA0679D	186,71		

SBA0679G Cayron

6 SBG0400M  14"









				
563	165	14	50-100	BTFC01440
				€
SBG0400MG	SBG0400MD	181,34		

SBG0400MG

2 SBB0369  14"-16"









				
550	140	14	50-70-70	BTFC01240
				€
SBB0369G	SBB0369D	185,21		

SBB0369G

7 SBG0600M  16"











				
635	150	14	50-140	BTFC01440
				€
SBG0600MG	SBG0600MD	197,80		

SBG0600MG

3 SBD0182  14"-16"









				
595	140	14	60-200	BTFC01240
				€
SBD0182G	SBD0182D	185,21		
	SBD0182-12G	SBD0182-12D	127,72	

SBD0182-12G

8 SBG0401  14"









				
460	125	14	90-100	BTFC01235GB
				€
SBG0401G	SBG0401D	156,88		

SBG0401G

4 SBD0429M  14"











				
540	140	14	50-120	BTFC01440
				€
SBD0429MG	SBD0429MD	185,21		

SBD0429MG

9 SBG0423M  14"









				
507	140	12	50-110-90-100	BTFC01440
				€
SBG0423MG	SBG0423MD	179,63		
	SBG0423-12MG	SBG0423-12MD	127,72	

SBG0423-12MG

5 SBD7361M  14"









				
540	140	14	55-120	BTFC01440
				€
SBD7361MG	SBD7361MD	181,55		

SBD7361MG

10 SBG0601  16"



				
510	125	14	90-100	BTFC01235GB
				€
SBG0601G	SBG0601D	164,42		

SBG0601G

11 SBG0613M Q 16"



610	145	12	50-110-90-100	BTFC1440
<		>		€
SBG0613MG	SBG0613MD	185,21		
SBG0613-12MG	SBG0613-12MD	139,08		

SBG0613-12MG 

12 SBG0813 Q 18"



570	125	14	90-100	BTFC1235GB
<		>		€
SBG0813G	SBG0813D	173,47		

SBG0813G

13 SBG8123M Q 14"



550	145	12	50-110-90-100	BTFC1440
<		>		€
SBG8123MG	SBG8123MD	179,63		
SBG8123-12MG	SBG8123-12MD	127,72		

SBG8123MG 

14 SBG8125M Q 16"





604	150	12	50-110-90-100	BTFC1440
<		>		€
SBG8125MG	SBG8125MD	185,21		
SBG8125-12MG	SBG8125-12MD	139,08		









SBG8125-12MG 

CORRESPONDANCE CORRESPONDENCIA KORRESPONDENZ CORRESPONDENCE					
		<		>	
N°	TYPE TIP TYP	AGRICARB	ORIGINE	AGRICARB	ORIGINE
1	Amazone	SBA 0679G	72000679	SBA 0679D	72000678
2	Bonnel	SBB 0369G	13200010 13200008	SBB 0369D	13200010 13200008
3	Demblon	SBD 0182G	5182G	SBD 0182D	5182D
		SBD 0182-12G	5182G	SBD 0182-12D	5182D
4	Duro	SBD 0429MG	6429	SBD 0429MD	6430
5		SBD 7361MG	7361	SBD 7361MD	7362
6	Goizin	SBG 0400MG	010450	SBG 0400MD	010400
7		SBG 0600MG	010650	SBG 0600MD	010600
8	Grégoire-Besson	SBG 0401G	172401 172417 172429	SBG 0401D	172402 172418 172430
9		SBG 0423-12MG	173423 173433	SBG 0423-12MD	173424 173434
10		SBG 0423MG	173423 173433	SBG 0423MD	173424 173434
		SBG 0601G	172601 172613 172615	SBG 0601D	172602 172614 172616
11		SBG 0613-12MG	173613G	SBG 0613-12MD	173614D
		SBG 0613MG	173613G	SBG 0613MD	173614D
12		SBG 0813G	172813	SBG 0813D	172814
13		SBG 8123-12MD	178124 173424	SBG 8123-12MD	178124 173424
		SBG 8123MG	178123 173423	SBG 8123MD	178124 173424
14		SBG 8125-12MG	178125	SBG 8125-12MG	178125
		SBG 8125MG	178125	SBG 8125MD	178126



15 SBH0102  14"



				
610	160	14	52-60-110-135	
				
SBH0102G		SBH0102D		197,80

SBH0102G

20 SBH0166M  14"



				
565	160	14	52-60-110-135	BTF2E1440
				
SBH0166MG		SBH0166MD		194,11

SBH0166MG

16 SBH0134M  14"











				
600	160	14	52-60-110-135	BTF2E1440
				
SBH0134MG		SBH0134MD		185,21

SBH0134MG

21 SBH0170  14"











				
610	160	14	52-60-110-135	BTF2E1440
				
SBH0170G		SBH0170D		192,10

SBH0170G

17 SBH0136M  16"











				
650	160	12	52-60-110-135	BTF2E1440
				
SBH0136MG		SBH0136MD		195,93
SBH0136-12MG		SBH0136-12MD		139,08

SBH0136-12MG

22 SBH0172M  16"



				
625	160	14	52-60-110-135	BTF2E1440
				
SBH0172MG		SBH0172MD		199,66

SBH0172MG

18 SBH0140M  14"



				
570	160	14	52-60-200	
				
SBH0140MG		SBH0140MD		185,21

SBH0140MG

23 SBH0200M  14"



				
535	160	14	52-60-110-135	BTF2E1440
				
SBH0200MG		SBH0200MD		188,40

SBH0200MG

19 SBH0142M  16"



				
650	160	14	52-60-200-100	
				
SBH0142MG		SBH0142MD		199,66

SBH0142MG

24 SBH0202M  16"



				
625	160	14	52-60-110-135	BTF2E1440
				
SBH0202MG		SBH0202MD		199,66

SBH0202MG

25 SBH0416M Q 16"



↕	↔	↔	↔	⊕
645	160	14	52-60-110-135	
<	>		€	
SBH0416MG	SBH0416MD	211,04		

SBH0416MG

26 SBH0800M Q



↕	↔	↔	↔	⊕
651	155	15	52-60-110-135	BTF2E1440
<	>		€	
SBH0800MG	SBH0800MD	186,60		

SBH0800MG

27 SBH0862M Q 14"



↕	↔	↔	↔	⊕
570	160	14	52-60-110-135	
<	>		€	
SBH0862MG	SBH0862MD	195,93		

SBH0862MG

28 SBH0865M Q 16"



↕	↔	↔	↔	⊕
625	160	14	52-60-110-135	
<	>		€	
SBH0865MG	SBH0865MD	209,04		

SBH0865MG

29 SBH0884M Q 14"



↕	↔	↔	↔	⊕
600	160	12	52-60-110-135	
<	>		€	
SBH0884MG	SBH0884MD	190,43		
SBH0884-12MG	SBH0884-12MD	134,84		

SBH0884-12MG

CORRESPONDANCE CORRESPONDENCIA KORRESPONDENZ CORRESPONDENCE					
		<		>	
N°	TYPE TIP TYP	AGRICARB	ORIGINE	AGRICARB	ORIGINE
15		SBH 0102G	583103	SBH 0102D	583102
16		SBH 0134MG	622135 622243	SBH 0134MD	622134 622242
17		SBH 0136-12MG	622137 622213 622252	SBH 0136-12MD	622136 622212 622250
18		SBH 0136MG	622137 622213 622252	SBH 0136MD	622136 622212 622250
19		SBH 0140MG	622141 622007 622199 622247	SBH 0140MD	622140 622006 622198 622246
20		SBH 0142MG	622143 622255	SBH 0142MD	622142 622254
21		SBH 0166MG	622167	SBH 0166MD	622166
22	Kuhn-Huard	SBH 0170G	622171	SBH 0170D	622170
23		SBH 0172MG	622173	SBH 0172MD	622172
24		SBH 0200MG	622201 622233	SBH 0200MD	622200 622232
25		SBH 0202MG	622203 622235 0402770	SBH 0202MD	622202 622234 0402760
26		SBH 0416MG	581417	SBH 0416MD	581416
27		SBH 0800MG	H0405810	SBH 0800MD	H0405800
28		SBH 0862MG	582863	SBH 0862MD	582862
29		SBH 0865MG	582865 583893	SBH 0865MD	582864 583892
		SBH 0884-12MG	580885	SBH 0884-12MD	580884
		SBH 0884MG	580885	SBH 0884MD	580884

30 SBH0886M Q 16"



650	160	12	52-60-110-135	
<		>		€
SBH0886MG	SBH0886MD	199,66		
SBH0886-12MG	SBH0886-12MD	146,21		

SBH0886-12MG

35 SBK3014 Q 14"



500	145	14	40-85-120-120	BTC2M1239
<		>		€
SBK3014G	SBK3014D	181,34		

SBK3014G

31 SBH1140M Q 14"



565	160	14	52-60-110-135	
<		>		€
SBH1140MG	SBH1140MD	199,66		

SBH1140MG

36 SBK3056M Q 16"



540	145	15	40-95-120-110	BTC1M1440-NY
<		>		€
SBK3056MG	SBK3056MD	186,42		

SBK3056MG

32 SBK3002M Q 14"



500	145	14	40-95-120-110	BTC1M1440-NY
<		>		€
SBK3002MG	SBK3002MD	177,20		

SBK3002MG

37 SBK3080M Q 18"



635	145	14	40-85-120-120	BTC1M1440-NY
<		>		€
SBK3080MG	SBK3080MD	197,80		

SBK3080MG

33 SBK3004M Q 16"



565	145	12	40-95-120-110	BTC1M1440-NY
<		>		€
SBK3004MG	SBK3004MD	177,20		
SBK3004-12MG	SBK3004-12MD	127,72		

SBK3004-12MG

38 SBL2010 Q 14"



360	140	14	136	BTFCC1240
<		>		€
SBL2010G	SBL2010D	165,53		

SBL2010G

34 SBK3006M Q 18"



630	145	14	40-95-120-110	BTC1M1440-NY
<		>		€
SBK3006MG	SBK3006MD	186,42		

SBK3006MG

39 SBL2020 Q 16"



430	140	14	136	BTFCC1240
<		>		€
SBL2020G	SBL2020D	171,21		

SBL2020G

40 SBL2030 Q 18"



500	140	12	136	BTFCC1240
SBL2030G		SBL2030D		190,43
SBL2030-12G		SBL2030-12D		139,08

SBL2030-12G

41 SBL2034 Q 20"



500	140	14	135	BTFCC1240
SBL2034G		SBL2034D		190,43
SBL2034-12G		SBL2034-12D		139,08

SBL2034-12G

42 SBL2138 Q 20"



565	140	14	135-137	BTFCC1240
SBL2138G		SBL2138D		197,55

SBL2138G

43 SBN0452M Q 14"



575	150	12	90-100-120	BTF2E1440
SBN0452MG		SBN0452MD		177,20
SBN0452-12MG		SBN0452-12MD		139,08

SBN0452-12MG

CORRESPONDANCE CORRESPONDENCIA KORRESPONDENZ CORRESPONDENCE					
		<		>	
N°	TYPE TIP TYP	AGRICARB	ORIGINE	AGRICARB	ORIGINE
30	Kuhn-Huurd	SBH 0886-12MG	580887 583819	SBH 0886-12MD	580886 583818
		SBH 0886MG	580887 583819	SBH 0886MD	580886 583818
31		SBH 1140MG	581141	SBH 1140MD	581140
32	Kverneland-Kubota	SBK 3002MG	073003	SBK 3002MD	073002
33		SBK 3004-12MG	073005	SBK 3004-12MD	073004
		SBK 3004MG	073005	SBK 3004MD	073004
34		SBK 3006MG	073007	SBK 3006MD	073006
35		SBK 3014G	63017	SBK 3014D	63014
36		SBK 3056MG	073057	SBK 3056MD	073056
37		SBK 3080MG	073081	SBK 3080MD	073080
38	Lemken	SBL 2010G	3352011	SBL 2010D	3352010
39		SBL 2020G	3352021	SBL 2020D	3352020
		SBL 2030G	3352031 3352131	SBL 2030D	3352030 3352130
40		SBL 2030-12G	3352031 3352131	SBL 2030-12D	3352030 3352130
		SBL 2034G	3352035 3352135 3352235	SBL 2034D	3352034 3352134 3352234
41		SBL 2034-12G	3352035 3352135 3352235	SBL 2034-12D	3352034 3352134 3352234
42		SBL 2138G	3353139	SBL 2138D	3352138
43	Naud	SBN 0452-12MG	031189G	SBN 0452-12MD	031189D
		SBN 0452MG	031189G	SBN 0452MD	031189D
40	Opall Agri	SBL 2030G	40411-40-121-40	SBL 2030D	40411-40-111.40
		SBL 2030-12G	40411-40-121-40	SBL 2030-12D	40411-40-111.40
SBL 2034G		40411-40-121	SBL 2034D	40411-40-111	
41		SBL 2034-12G	3352035 3352135 3352235	SBL 2034-12D	3352034 3352134 3352234

44 SB04600M 🔍 16"(CorpsXL)

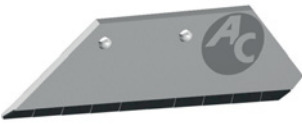

↕	↔	↔	↔	⊕
470	150	14	130	BTF2E1235
◀		▶		€
SB04600MG	SB04600MD	185,21		

SB04600MG

49 SBP0160 🔍 18"(Corps)-3035UW



↕	↔	↔	↔	⊕
575	160	14	95-130-120	BTC2M1239
◀		▶		€
SBP0160G	SBP0160D	218,59		

SBP0160G

45 SB05039 🔍 16"



↕	↔	↔	↔	⊕
475	110	14	145	BTF2E1235
◀		▶		€
SB05039G	SB05039D	173,05		

SB05039G

50 SBP1200 🔍 18"



↕	↔	↔	↔	⊕
665	150	14	50-90-115-115-115	BTC1M1440-NY
◀		▶		€
SBP1200G	SBP1200D	243,37		

SBP1200G

46 SB05381 🔍 14"(CorpsXL)



↕	↔	↔	↔	⊕
481	135	14	145	BTF2E1235
◀		▶		€
SB05381G	SB05381D	185,21		

SB05381G

51 SBR0293 🔍 14"



↕	↔	↔	↔	⊕
565	140	14	45-65-140	BTFCC1240
◀		▶		€
SBR0293G	SBR0293D	199,66		

SBR0293G

47 SB00279 🔍 14"



↕	↔	↔	↔	⊕
410	110	14	40-166	BTC2M1245-OB
◀		▶		€
SB00279G	SB00279D	165,52		

SB00279G

52 SBR0294M 🔍 16"



↕	↔	↔	↔	⊕
625	140	14	45-65-140	BTFCC1240
◀		▶		€
SBR0294MG	SBR0294MD	218,57		

SBR0294MG

48 SBV0043M 🔍 18" WSM43L



↕	↔	↔	↔	⊕
620	120	14	50-100-100	BTC2M1439
◀		▶		€
SBV0043MG	SBV0043MD	239,31		

SBV0043MG

Versatill

53 SBR0332 🔍 14"



↕	↔	↔	↔	⊕
550	140	14	45-105-55	BTFCC1240
◀		▶		€
SBR0332G	SBR0332D	185,21		

SBR0332G

54 SBR0350M

Q 16"



SBR0350MG

610	140	14	45-75-120-120	BTFCC1240
<		>		€
SBR0350MG		SBR0350MD		227,95

55 SBS0090-12

Q



SBS0090-12G

425	140	12	94-151	BTFCC1235
<		>		€
SBS0090-12G		SBS0090-12D		127,45

56 SBV0035

Q 12"



SBV0035G

530	120	14	50-100-100	BTC2M1439
<		>		€
SBV0035G		SBV0035D		197,80

57 SBV0040M

Q 16"



SBV0040MG

590	159	14	50-100-100	BTC2M1439
<		>		€
SBV0040MG		SBV0040MD		221,53

CORRESPONDANCE | CORRESPONDENCIA | KORRESPONDENZ | CORRESPONDENCE

N°	TYPE TIP TYP	<		>	
		AGRICARB	ORIGINE	AGRICARB	ORIGINE
44		SBO 4600MG	94601	SBO 4600MD	94600
45	Overum-New Holland	SBO 5039G	85195	SBO 5039D	85039
46		SBO 5381G	58538390	SBO 0279D	64000280
47	Ovlac	SBO 0279G	64000279	SBO 0279D	64000280
48		SBV 0043MG		SBV 0043MD	
36		SBK 3056MG	67073057	SBK 3056MD	67073056
49	Pöttinger	SBP 0160G	925131260 9251312611	SBP 0160D	925131160 9251311611
50		SBP 1200G	930411200	SBP 1200D	930401200
51		SBR 0293G	SSP2930S	SBR 0293D	SSP2930S
52	Rabewerk	SBR 0294MG	SSP2940SE	SBR 0294MD	SSP2940SE
53		SBR 0332G	SSP3320S	SBR 0332D	SSP3320S
54		SBR 0350MG	SSP3500S	SBR 0350MD	SSP3500S
55	Steno	SBS 0090-12G		SBS 0090-12D	
56		SBV 0035G	WSM35L PK601401AG	SBV 0035D	WSM35 PK601301AD
57	Vogel & Noot	SBV 0040MG	WSM40L PK701401AG	SBV 0040MD	WSM40 PK701301AD
48		SBV 0043MG	VNLK200108A LK200108A PK801401A	SBV 0043MD	VNLK200107A LK200107A PK801301A

1 RAB0060

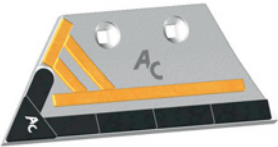

240	100	12	60	BTFCC1040
				€
RAB0060G		RAB0060D		80,06

RAB0060G

6 RAD080B

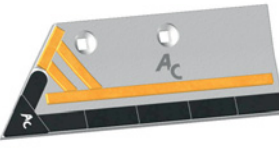

275	100	12	80	BTFCC1040
				€
RAD080BG		RAD080BD		82,57

RAD080BG

2 RAB060L

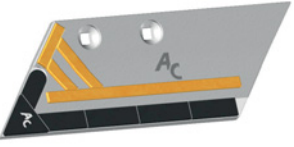

230	100	12	60	BTFCC1040
				€
RAB060LG		RAB060LD		80,06

RAB060LG

7 RAG0065

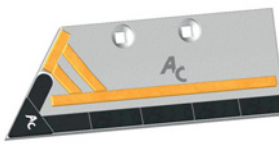

275	100	12	65	BTFCC1040
				€
RAG0065G		RAG0065D		82,57

RAG0065G

3 RAH064B

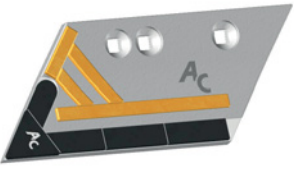

180	100	12	64-87	BTFCC1040
				€
RAH064BG		RAH064BD		76,30

RAH064BG

8 RAG065B

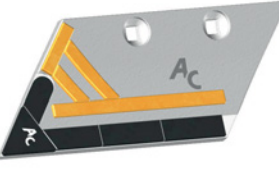

185	100	12	65	BTFCC1040
				€
RAG065BG		RAG065BD		76,30

RAG065BG

4 RAD0080

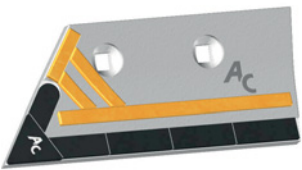

250	100	12	80	BTFCC1240
				€
RAD0080G		RAD0080D		80,06

RAD0080G

9 RAG0055



185	100	12	55	BTFCC1040
				€
RAG0055G		RAG0055D		76,30

RAG0055G

5 RAD8098

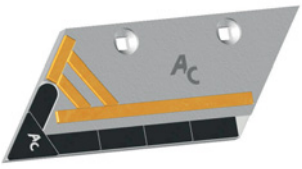

205	100	12	90	BTFCC1040
				€
RAD8098G		RAD8098D		80,06

RAD8098G

10 RAG0083

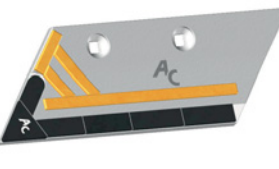

230	100	12	83	BTFCC1040
				€
RAG0083G		RAG0083D		80,06

RAG0083G

11 RAH0064

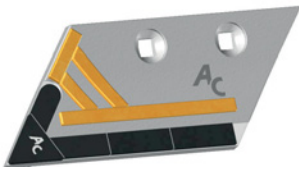

RAH0064G

185	100	12	64	BTFC1240
				€
RAH0064G		RAH0064D		76,30

12 RAH0084

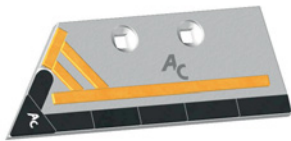

RAH0084G

275	100	12	84	BTFC1240
				€
RAH0084G		RAH0084D		82,57

13 RAH064T



RAH064TG

270	100	18	64	BTFC1240
				€
RAH064TG		RAH064TD		82,56

14 RAK0070

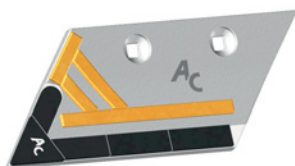

RAK0070G

185	100	12	70	BTFC1040
				€
RAK0070G		RAK0070D		76,30

15 RAK070L



RAK070LG

325	100	14	70	BTFC1040
				€
RAK070LG		RAK070LD		82,57

CORRESPONDANCE | CORRESPONDENCIA | KORRESPONDENZ | CORRESPONDENCE

N°	TYPE TIP TYP	AGRICARB	ORIGINE	AGRICARB	ORIGINE
1	Bonnel	RAB 0060G	20702	RAB 0060D	20702
2		RAB 060LG	30000006 4032031101	RAB 060LD	30000005 4032031100
3	Bugnot	RAH 064BG	5117	RAH 064BD	5116
4	Demblon	RAD 0080G	472	RAD 0080D	472
5	Dowdeswell	RAD 8098G	048099	RAD 8098D	048098
6	Duro	RAD 080BG	6603	RAD 080BD	6604
7	Goizin	RAG 0065G	010782	RAG 0065D	010732
8		RAG 065BG	10783	RAG 065BD	10733
9	Grégoire-Besson	RAG 0055G	19111 19114	RAG 0055D	19112 19113
10		RAG 0083G	19125 191198	RAG 0083D	19126 191197
11	Kuhn-Huurd	RAH 0064G	631101	RAH 0064D	631100
12		RAH 0084G	631031 631103	RAH 0084D	631030 631102
3		RAH 064BG	631107	RAH 064BD	631106
13		RAH 064TG	631109 631112	RAH 064TD	631108 631112
14	Kverneland	RAK 0070G	066873	RAK 0070D	056873
15		RAK 070LG	066869	RAK 070LD	066868



16 RAL0087

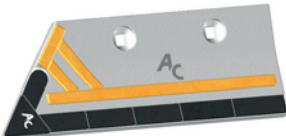

270	100	12	87	BTFCC1040
				€
RAL0087G		RAL0087D		82,57

RAL0087G

21 RAN090L

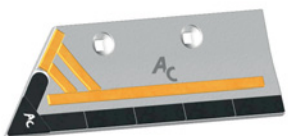

285	100	12	90	BTFCC1040
				€
RAN090LG		RAN090LD		82,57

RAN090LG

17 RAL087B



190	100	12	87	BTFCC1040
				€
RAL087BG		RAL087BD		76,30

RAL087BG

22 RA00105

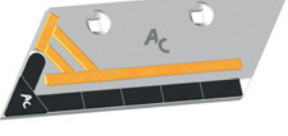

245	100	12	105	BTFCC1240
				€
RA00105G		RA00105D		80,06

RA00105G

18 RAL3723



245	100	12	87	BTFCC1040
				€
RAL3723G		RAL3723D		80,06

RAL3723G

23 RAR0060



225	100	12	60	BTFCC1040
				€
RAR0060G		RAR0060D		80,06

RAR0060G

19 RAL3729

NEW

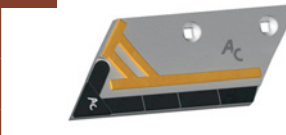

205	100	12	87	BTFCC1040
				€
RAL3729G		RAL3729D		80,06

RAL3729G

24 RAR0501

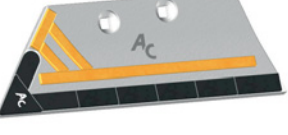

295	100	12	60	BTFCC1040
				€
RAR0501G		RAR0501D		82,57

RAR0501G

20 RAN0090



185	100	12	90	BTFCC1040
				€
RAN0090G		RAN0090D		76,30

RAN0090G

12 RAH0084

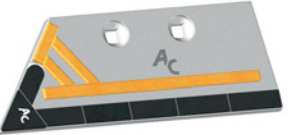

275	100	12	84	BTFCC1240
				€
RAH0084G		RAH0084D		82,57

RAH0084G

Rasettes dernière génération

skim points : new generation / Vorschälerschare neuste generation / rasetas nueva generación

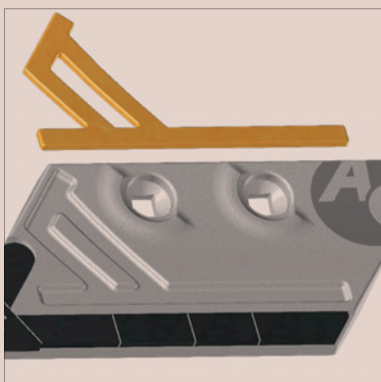
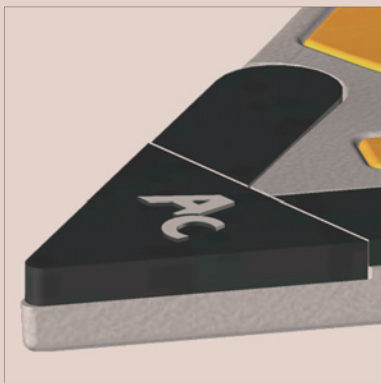
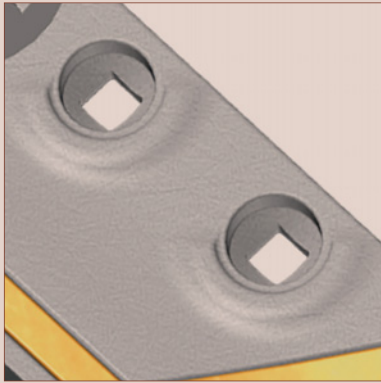









HR2

CORRESPONDANCE CORRESPONDENCIA KORRESPONDENZ CORRESPONDENCE					
		<		>	
N°	TYPE TIP TYP	AGRICARB	ORIGINE	AGRICARB	ORIGINE
16	Lemken	RAL 0087G	3363711	RAL 0087D	3363710
17		RAL 087BG	3363721	RAL 087BD	3363720
18		RAL 3723G	3363723	RAL 3723D	3363722
19		RAL 3729G	3363729	RAL 3729D	3363728
20	Naud	RAN 0090G	031240G	RAN 0090D	031240D
21		RAN 090LG	031241G	RAN 090LD	031241D
22	Overum-New Holland	RAO 0105G	591802	RAO 0105D	591801
23	Rabewerk	RAR 0060G	27156002	RAR 0060D	27156001
24		RAR 0501G	27150501	RAR 0501D	27150502
12	Vogel & Noot	RAH 0084G	PA305401 LZ135701G	RAH 0084D	PA305501 LZ135601D











1 COR5020  Cornière pour contre-seps

				
130	50	20	/	/
				
COR5020			58,83	
				









COR5020

6 CSG3388 

				
580	120	14	310	BTFC1235GB
				
CSG3388G			CSG3388D	
			139,85	
				









CSG3388G

2 CSD3491  **NEW**

				
564	100	15	80-240	BTFC1235
				
CSD3491G			CSD3491D	
			114,95	
				









CSD3491G

7 CSG7319 

				
620	120	15	310	BTFC1235GB
				
CSG7319G			CSG7319D	
			139,85	
				









CSG7319G

3 CSD3563  **NEW**

				
640	100	15	80-240-160	BTFC1235
				
CSD3563G			CSD3563D	
			139,85	
				









CSD3563G

8 CSG7349 

				
280	120	14	90	BTFC1250
				
CSG7349G			CSG7349D	
			114,95	
				









CSG7349G

4 CSG2338 

				
455	80	14	240-310	BTFC1235GB
				
CSG2338G			CSG2338D	
			114,95	
				









CSG2338G

9 CSH0106 

				
157	110	14	65	BTC2M1239
				
CSH0106G			CSH0106D	
			63,03	
				









CSH0106G

5 CSG2380 

				
600	120	15	240	BTFC1235GB
				
CSG2380G			CSG2380D	
			145,34	
				

CSG2380G

10 CSH0108 

				
550	110	14	95	BTC2M1239
				
CSH0108				
			183,67	
				

CSH0108

11 CSH0120

Q

↕	↔	↗↖	↻	⊕
195	110	14	65	BTC2M1239
<		>		€
CSH0120G		CSH0120D		70,38



CSH0120G

12 CSH0122

Q

↕	↔	↗↖	↻	⊕
450	110	14	192	BTC2M1239
<		>		€
CSH0122				139,85



CSH0122

13 CSH0138

Q

↕	↔	↗↖	↻	⊕
155	110	14	50	BTC2M1239
<		>		€
CSH0138G		CSH0138D		63,03



CSH0138G

14 CSH0152

Q

↕	↔	↗↖	↻	⊕
373	70	14	157	BTC2M1239
<		>		€
CSH0152				138,51



CSH0152

15 CSH1111

Q L / L FAST-FIST / L SELECT / N4
SELECT / SL / V / VL

↕	↔	↗↖	↻	⊕
152	109	14	50	BTC2M1239
<		>		€
CSH1111G		CSH1111D		63,03





CSH1111G







CORRESPONDANCE | CORRESPONDENCIA | KORRESPONDENZ | CORRESPONDENCE

		<		>	
N°	TYPE TIP TYP	AGRICARB	ORIGINE	AGRICARB	ORIGINE
1		COR 5020		COR 5020	
2	Demblon	CSD 3491G	3491G	CSD 3491D	3491D
3		CSD 3563G	3563G	CSD 3563D	3563D
4		CSG 2338G	172338-240 173338-310	CSG 2338D	172338-240 173338-310
5		CSG 2380G	172380-240 (carrelet)	CSG 2380D	172380-240 (carrelet)
6	Grégoire-Besson	CSG 3388G	173388-310 (pointe)	CSG 3388D	173388-310 (pointe)
7		CSG 7319G	177319	CSG 7319D	177319
8		CSG 7349G	177349	CSG 7349D	177349
9		CSH 0106G	761106	CSH 0106D	761106
10		CSH 0108	761108	CSH 0108	761108
11		CSH 0120G	233120	CSH 0120D	233120
12	Kuhn-Huard	CSH 0122	233122	CSH 0122	233122
13		CSH 0138G	279138 279139 761111	CSH 0138D	279138 279139 761110
14		CSH 0152	279152	CSH 0152	279152
15		CSH 1111G	761111G	CSH 1111D	761110D
16		CSH 9140	279140	CSH 9140	279140



16 CSH9140 







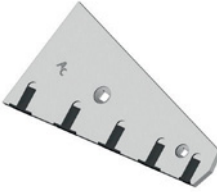

				
550	130	15	95	BTC2M1239
				
CSH9140			€	
			183,67	

CSH9140

21 CSL1525 







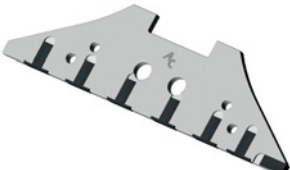

				
429	227	14	204	BTFCC1640 BTFCC1240
				
CSL1525G			€	
			121,73	

CSL1525G

17 CSK0608 









				
568	160	14	270 - 330	BTC1M1440-NY
				
CSK0608G			€	
			143,96	

CSK0608G

22 CSL1900 









				
190	120	14	100	BTFCC1040
				
CSL1900G			€	
			66,18	

CSL1900G

18 CSK0609 









				
748	160	14	90 - 510 - 620	BTC1M1440-NY
				
CSK0609G			€	
			194,61	

CSK0609G

23 CSL1903 







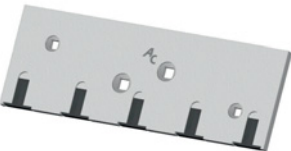

				
165	103	14	/	BTFCC1035 BTHEX1025-NY
				
CSL1903G			€	
			67,13	

CSL1903G

19 CSL0006 









				
460	150	12	155 - 155	BTFCC Ø 12 mm BTFCC Ø 16 mm
				
CSL0006G			€	
			146,91	

CSL0006G

24 CSN0501 









				
330	150	14	110	BTF2E1440
				
CSN0501			€	
			91,68	

CSN0501

20 CSL0504 



				
420	110	14	155 - 155	BTFCC1240
				
CSL0504			€	
			146,91	

CSL0504

COR.5020

**Pour tous contre-seps
hors catalogue**

*For off-catalogue landsides.
Diese Anschweißteile sind für alle Anlagen die nicht im Katalog sind.
Para toda talonera fuera de catálogo.*

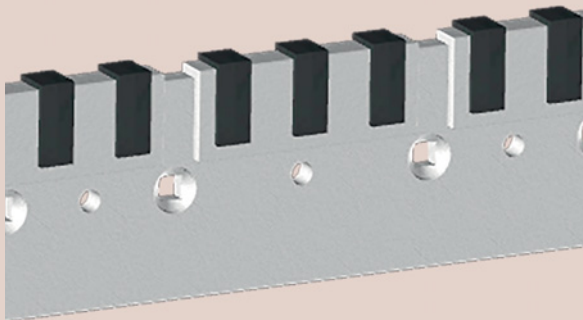
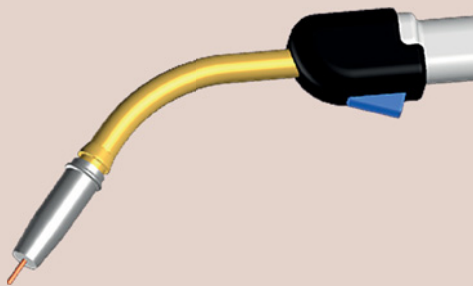
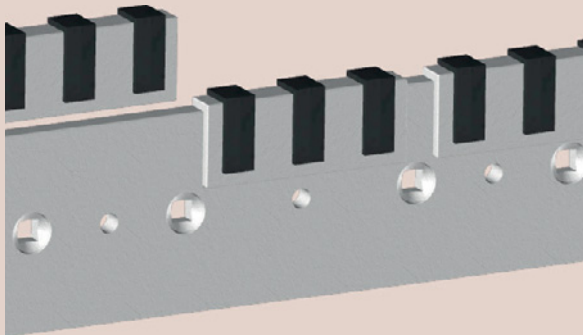
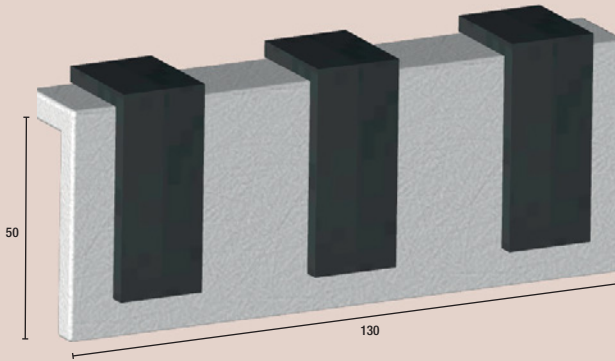

CORRESPONDANCE CORRESPONDENCIA KORRESPONDENZ CORRESPONDENCE					
		<		>	
N°	TYPE TIP TYP	AGRICARB	ORIGINE	AGRICARB	ORIGINE
17	Kverneland	CSK 0608G	73608	CSK 0608D	73608
18		CSK 0609G	73609	CSK 0609D	73609
19		CSL 0006G	34110006	CSL 0006D	34110006
20		CSL 0504	3411504	CSL 0504	3411504
21	Lemken	CSL 1525G	3411525	CSL 1525D	3411525
22		CSL 1900G	3401901 3401900	CSL 1900D	3401901 3401900
23		CSL 1903G	3401903	CSL 1903D	3401903
24	Naud	CSN 0501	031191	CSN 0501	031191
20	Opall Agri	CSL 0504	40411-04-064	CSL 0504	40411-04-064
22		CSL 1900G	40411-04-081 40411-04-082	CSL 1900D	40411-04-081 40411-04-082



Préparation du sol

Soil preparation

Bodenbearbeitung

Preparación del suelo

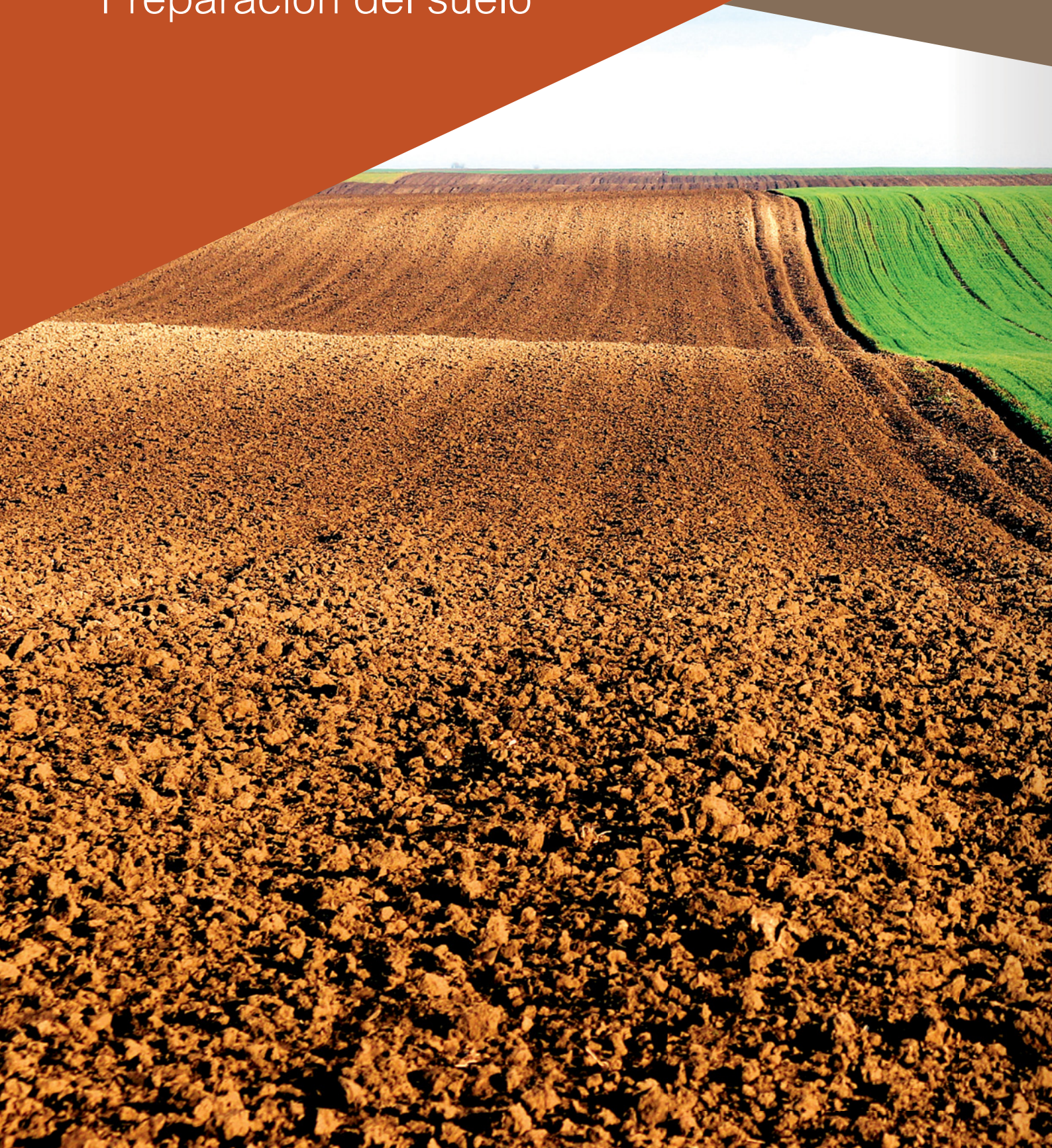

▲ **Dents de herses** 92

Power harrow tines

Kreiseleggenzinken

Dientes de grada rotativa

▲ **Socs vibroculteurs, Dents rototiller, Lames de fraise & Dents de herse etrille** 104

Tines for vibro cultivators, Rototiller, Rotovator blade & Harrow tine

Vibrationseggenzinken, Zinken für Bodenfräse, Fräsmesser & Striegelzinken

Puntas vibrocultivador, Dientes rototiller, Cuchilla de rotovator & Pùas rastrillo

▲ **Dents de butteuses de pommes de terre** 110

Potato ridger tines

Fräshaken für Dammmfräse

Dientes para fresadora de patatas

▲ **Grattoirs** 112

Scrapers

Abstreifer

Rascadores



▲ **Socs triangulaires, Soc de bineuses & Prestations de soudage** 118

Point winged, Duckfoot point & Welding service on point winged





Gänsefußschare, Hackschare & Umbau von Gänsefußschare

Alas de golondrinas, Rejas golondrina & Prestación de soldadura



1 DAG3619   **DAG3619-3D** 



				
315	110	16	50	BTHEX1860-150-NY
				€
DAG3619G		DAG3619D		52,07
DAG3619-3G		DAG3619-3D		70,00

DAG3619-3D

6 DHAL0470-O   **DHAL0470-03D** 

NEW



				
310	100	14	60	Ø 22 mm / BTHEX1660-150-NYEM
				€
DHAL0470-0G		DHAL0470-0D		71,21
DHAL0470-03G		DHAL0470-03D		89,15
DHAL0470-0LTG		DHAL0470-0LTD		97,87

DHAL0470-OD DHAL0470-OLT

DTEK

2 DKV0018   **DKV0018-3D** 



				
330	110	18	50	BTHEX1860-150-NY
				€
DKV0018G		DKV0018D		52,07
DKV0018-3G		DKV0018-3D		70,00

DKV0018-3D

7 DHAL5650   **DHAL5650-3D** 



				
315	100	15	/	Ø 22 mm
				€
DHAL5650G		DHAL5650D		59,24
DHAL5650-3G		DHAL5650-3D		77,18

DHAL5650-3D

3 DHAL0114-O   **DHAL0114-03D** 



				
325	100	18	60	
				€
DHAL0114-0D		DHAL0114-0D		67,04
DHAL0114-03G		DHAL0114-03D		84,97
DHAL0114-0LTG		DHAL0114-0LTD		93,70

DHAL0114-OD DHAL0114-OLT

8 DHAL7400-O   **DHAL7400-03D** 



				
315	110	18	60	BTHEX1660-150-NYEM
				€
DHAL7400-0G		DHAL7400-0D		59,24
DHAL7400-03G		DHAL7400-03D		77,18
DHAL7400-0LTG		DHAL7400-0LTD		84,73

DHAL7400-03D DHAL7400-OLT

4 DHAL0288-O   **DHAL0288-03D** 



				
310	100	14	/	Ø 22 mm
				€
DHAL0288-0G		DHAL0288-0D		71,21
DHAL0288-03G		DHAL0288-03D		89,15
DHAL0288-0LTG		DHAL0288-0LTD		97,87

DHAL0288-03D DHAL0288-OLT

9 DMA0007   **DMA0007-3D** 



				
280	100	15	60	BTHEX1660-150-NYEM
				€
DMA0007G		DMA0007D		52,07
DMA0007-3G		DMA0007-3D		70,00
DMA0007-LTG		DMA0007-LTD		76,84

DMA0007-3D DMA0007-LTD

5 DHAL0454-O   **DHAL0454-03D** 



				
320	120	18	75	Ø20
				€
DHAL0454-0G		DHAL0454-0D		71,21
DHAL0454-03G		DHAL0454-03D		89,15
DHAL0454-0LTG		DHAL0454-0LTD		97,87

DHAL0454-03D DHAL0454-OLT

10 DAA0312A  











				
320	110	12	80	Ø 12 mm
				€
DAA0312AR				52,07
DAA0312AV				52,07



DAA0312AR DAA0312AV

11 DAM2337-0  **DAM2337-03D** 











				
340	120	14	/	Ø 20 mm
				
DAM2337-0G	DAM2337-0D	71,21		
DAM2337-03G	DAM2337-03D	89,15		
				



DAM2337-03D

12 DHA2774F-0  **DHA2774F-03D** 











				
430	120	15	/	Ø 18 mm
				
DHA2774F-0G	DHA2774F-0D	89,15		
DHA2774F-03G	DHA2774F-03D	107,10		
 Cultimix				

DHA2774F-03D

13 DHA2774-0  **DHA2774-03D** 



				
430	120	15	/	Ø 18 mm
				
DHA2774-0G	DHA2774-0D	89,15		
DHA2774-03G	DHA2774-03D	107,10		
 Cultimix				

DHA2774-03D



14 DHA2980-0  **DHA2980-03D** 

NEW











				
				
DHA2980-0G	DHA2980-0D	71,21		
DHA2980-03G	DHA2980-03D	89,15		
DHA2980-0LTG	DHA2980-0LTD	97,88		
				

DHA2980-0D DHA2980-03LT

15 DHA7496  **DHA7496-3D** 



				
340	120	15	/	Ø 18 mm
				
DHA7496G	DHA7496D	52,07		
DHA7496-3G	DHA7496-3D	70,00		
DHA7496-LTG	DHA7496-LTD	76,84		
DHA7496-0G	DHA7496-0D	71,21		
DHA7496-03G	DHA7496-03D	89,15		
 Cultimix				

DHA7496-3D DHA7496-3LT

CORRESPONDANCE CORRESPONDENCIA KORRESPONDENZ CORRESPONDENCE					
		<		>	
N°	TYPE TIP TYP	AGRICARB	ORIGINE	AGRICARB	ORIGINE
1	Agram	DAG 3619-3G	53361900	DAG 3619-3D	53361900
		DAG 3619G	53361900	DAG 3619D	53361900
		DKV 0018-3G	RH85	DKV 0018-3D	RH85
		DKV 0018G	RH85	DKV 0018D	RH85
2	Agram	DHAL 0114-0G	MK0A00118 D06701A	DHAL 0114-0D	MK0A00114 D06700A
		DHAL 0114-03G	MK0A00118 D06701A	DHAL 0114-03D	MK0A00114 D06700A
		DHAL 0114-0LTG	MK0A00118 D06700A	DHAL 0114-0LTD	MK0A00114 D06700A
		DHAL 0288-03G	MK0A00288 MK0A00400	DHAL 0288-03D	MK0A00287 MK0A00399
3	Agram	DHAL 0288-0G	MK0A00288 MK0A00400	DHAL 0288-0D	MK0A00287 MK0A00399
		DHAL 0288-0LTG	MK0A00288 MK0A00400	DHAL 0288-0LTD	MK0A00287 MK0A00399
		DHAL 0454-0G	MK0A00453 MK0A00319 MK0A00321	DHAL 0454-0D	MK0A00454 MK0A00320 MK0A00322
		DHAL 0454-03G	MK0A00453 MK0A00319 MK0A00321	DHAL 0454-03D	MK0A00454 MK0A00320 MK0A00322
4	Agram	DHAL 0454-0LTG	MK0A00453 MK0A00319 MK0A00321	DHAL 0454-0LTD	MK0A00454 MK0A00320 MK0A00322
		DHAL 0470-0G	MK0A00469 MK0A00118 MK0A00400 MK0A00288	DHAL 0470-0D	MK0A00470 MK0A00114 MK0A00399 MK0A00287
		DHAL 0470-03G	MK0A00469 MK0A00118 MK0A00400 MK0A00288	DHAL 0470-03D	MK0A00470 MK0A00114 MK0A00399 MK0A00287
		DHAL 0470-0LTG	MK0A00469 MK0A00118 MK0A00400 MK0A00288	DHAL 0470-0LTD	MK0A00470 MK0A00114 MK0A00399 MK0A00287
5	Alpego	DHAL 5650-3G	D05650	DHAL 5650-3D	D05651
		DHAL 5650G	D05650	DHAL 5650D	D05651
		DHAL 7400-03G	D07401	DHAL 7400-03D	D07400
		DHAL 7400-0G	D07401	DHAL 7400-0D	D07400
6	Alpego	DHAL 7400-0LTG	D07401	DHAL 7400-0LTD	D07400
		DMA 0007-3G	D06700 MK0A00119	DMA 0007-3D	D06701 MK0A00115
		DMA 0007G	D06700 MK0A00119	DMA 0007D	D06701 MK0A00115
		DMA 0007-LTG	D06700 MK0A00119	DMA 0007-LTD	D06701 MK0A00115
7	Alpego	DAA 0312AR	63031	DAA 0312AV	63021
		DAM 2337-03G	962338	DAM 2337-03D	962337
		DAM 2337-0G	962338	DAM 2337-0D	962337
		DHA 2774F-03G	952775	DHA 2774F-03D	952774
8	Alpego	DHA 2774F-0G	952775	DHA 2774F-0D	952774
		DHA 2774-03G	952775	DHA 2774-03D	952774
		DHA 2774-0G	952775	DHA 2774-0D	952774
		DHA 2980-0G	232981	DHA 2980-0D	232980
9	Alpego	DHA 2980-03G	232981	DHA 2980-03D	232980
		DHA 2980-0LTG	232981	DHA 2980-0LTD	232980
		DHA 7496-3G	967496 6575300G 967496	DHA 7496-3D	967495 6574300D 967495
		DHA 7496G	6575300G 967496	DHA 7496D	6574300D 967495
10	Alpego	DHA 7496-LTG	6575300G 967496	DHA 7496-LTD	6574300D 967495
		DHA 7496-03G	6575300G 967496	DHA 7496-03D	6574300D 967495
		DHA 7496-0G	6575300G 967496	DHA 7496-0D	6574300D 967495
		DHA 7496-03G	6575300G 967496	DHA 7496-03D	6574300D 967495
11	Alpego	DHA 7496-0G	6575300G 967496	DHA 7496-0D	6574300D 967495
		DHA 7496-03G	6575300G 967496	DHA 7496-03D	6574300D 967495
		DHA 7496-0G	6575300G 967496	DHA 7496-0D	6574300D 967495
		DHA 7496-03G	6575300G 967496	DHA 7496-03D	6574300D 967495
12	Alpego	DHA 7496-0G	6575300G 967496	DHA 7496-0D	6574300D 967495
		DHA 7496-03G	6575300G 967496	DHA 7496-03D	6574300D 967495
		DHA 7496-0G	6575300G 967496	DHA 7496-0D	6574300D 967495
		DHA 7496-03G	6575300G 967496	DHA 7496-03D	6574300D 967495
13	Alpego	DHA 7496-0G	6575300G 967496	DHA 7496-0D	6574300D 967495
		DHA 7496-03G	6575300G 967496	DHA 7496-03D	6574300D 967495
		DHA 7496-0G	6575300G 967496	DHA 7496-0D	6574300D 967495
		DHA 7496-03G	6575300G 967496	DHA 7496-03D	6574300D 967495
14	Alpego	DHA 7496-0G	6575300G 967496	DHA 7496-0D	6574300D 967495
		DHA 7496-03G	6575300G 967496	DHA 7496-03D	6574300D 967495
		DHA 7496-0G	6575300G 967496	DHA 7496-0D	6574300D 967495
		DHA 7496-03G	6575300G 967496	DHA 7496-03D	6574300D 967495
15	Alpego	DHA 7496-0G	6575300G 967496	DHA 7496-0D	6574300D 967495
		DHA 7496-03G	6575300G 967496	DHA 7496-03D	6574300D 967495
		DHA 7496-0G	6575300G 967496	DHA 7496-0D	6574300D 967495
		DHA 7496-03G	6575300G 967496	DHA 7496-03D	6574300D 967495

16 DHA7496F   **DHA7496F-3D** 



				
340	120	15	/	Ø 18 mm
				€
DHA7496F-OG	DHA7496F-OD	71,21		
DHA7496F-03G	DHA7496F-03D	89,15		
DHA7496FG	DHA7496FD	52,07		
DHA7496F-3G	DHA7496F-3D	70,00		
DHA7496F-LTG	DHA7496F-LTD	76,84		

DHA7496F-3D DHA7496F-LTD 

Cultimix



21 DLM7022   **DLM7022-3D** 











				
310	110	15	70	BTHEX1660-150-NYEM
				€
DLM7022G	DLM7022D	55,65		
DLM7022-3G	DLM7022-3D	73,60		
DLM7022-LTG	DLM7022-LTD	80,80		

DLM7022-3D DLM7022-LTD 



Zirkon 7, Energy

17 DKE0021   **DKE0021-3D** 









				
345	120	12	82	BTHEX1660-150-NYEM
				€
DKE0021G	DKE0021D	52,07		
DKE0021-3G	DKE0021-3D	70,00		

DKE0021-3D KE

22 DFA0129   **DFA0129-3D** 



				
310	110	15	70	BTHEX1660-150-NYEM
				€
DFA0129G	DFA0129D	55,65		
DFA0129-3G	DFA0129-3D	73,60		



DFA0129-3D KE

18 DKE0302  









				
260	60	15	/	Ø 18 mm
				€
DKE0302G	DKE0302D	52,07		
DKE0302-OG	DKE0302-OD	61,03		

DKE0302D KE

23 DMA0006   **DMA0006-3D** 



				
280	90	15	50	BTHEX1660-150-NYEM
				€
DMA0006G	DMA0006D	52,07		
DMA0006-3G	DMA0006-3D	70,00		

DMA0006-3D Diamente, Master

19 DKE0303   **DKE0303-3D** 



				
290	60	18	/	Ø 18 mm
				€
DKE0303G	DKE0303D	52,07		
DKE0303-3G	DKE0303-3D	70,00		
DKE0303-LTG	DKE0303-LTD	76,84		
DKE0303-OG	DKE0303-OD	59,24		
DKE0303-03G	DKE0303-03D	77,18		

DKE0303-3D DKE0303-LTD 

KE

24 DMA0007   **DMA0007-3D** 



				
280	100	15	60	BTHEX1660-150-NYEM
				€
DMA0007G	DMA0007D	52,07		
DMA0007-3G	DMA0007-3D	70,00		
DMA0007-LTG	DMA0007-LTD	76,84		

DMA0007-3D DMA0007-LTD 

KE



20 DBR0184   **DBR0184-3D** 











				
305	100	15	60	Ø 16,5 mm
				€
DBR0184G	DBR0184D	50,30		
DBR0184-3G	DBR0184-3D	67,64		
DBR0184-LTG	DBR0184-LTD	74,24		

DBR0184D DBR0184-LTD 

KE



25 DVC0008   **DVC0008-3D** 



				
310	110	15	60	BTHEX2060-150-NY
				€
DVC0008G	DVC0008D	52,83		
DVC0008-3G	DVC0008-3D	71,05		









DVC0008-3D KE



Top

26 DF01001   **DF01001-3D** 











DF01001D



				
260	80	12	40	Ø 14 mm
				
DF01001G	DF01001D	52,06		
DF01001-3G	DF01001-3D	70,01		
				

27 DF08001   **DF08001-3D** 











DF08001D

				
300	90	14	50	Ø 16 mm
				
DF08001G	DF08001D	52,06		
DF08001-3G	DF08001-3D	70,01		
				

28 DF08005   **DF08005-3D** 



DF08005D



				
310	100	15		Ø 19,2 mm
				
DF08005G	DF08005D	71,21		
DF08005-3G	DF08005-3D	89,15		
				

29 DKU2590   **DKU2590-3D** 













DKU2590D LT



				
315	120	16	/	Ø 20 mm
				
DKU2590G	DKU2590D	52,07		
DKU2590-3G	DKU2590-3D	70,00		
DKU2590-LTG	DKU2590-LTD	76,84		
				



30 DH02937   **DH02937-3D** 











DH02937D

				
280	100	14	60	BTHX1460-NYEM
				
DH02937G	DH02937D	52,07		
DH02937-3G	DH02937-3D	70,00		
				

CORRESPONDANCE CORRESPONDENCIA KORRESPONDENZ CORRESPONDENCE					
					
N°	TYPE I TIP I TYP	AGRICARB	ORIGINE	AGRICARB	ORIGINE
16	Amazone	DHA 7496F-3G	967496 6575300G	DHA 7496F-3D	967495 6574300D
		DHA 7496FG	967496 6575300G	DHA 7496FD	967495 6574300D
		DHA 7496F-LTG	967496 6575300G	DHA 7496F-LTD	967495 6574300D
		DHA 7496F-03G	967496 6575300G	DHA 7496F-03D	967495 6574300D
		DHA 7496F-0G	967496 6575300G	DHA 7496F-0D	967495 6574300D
		DKE 0021-3G	6808400 68044	DKE 0021-3D	6807400 68024
		DKE 0021G	6808400 68044	DKE 0021D	6807400 68024
		DKE 0302G	950789	DKE 0302D	950788
		DKE 0302-0G	9510120	DKE 0302-0D	9510110
		DKE 0303-3G	954427	DKE 0303-3D	954426
17	Amazone	DKE 0303G	954427	DKE 0303D	954426
		DKE 0303-LTG	954427	DKE 0303-LTD	954426
		DKE 0303-03G	954427	DKE 0303-03D	954426
		DKE 0303-0G	954427	DKE 0303-0D	954426
18	Amazone	DBR 0184G	60184 60184G	DBR 0184D	60184 60184D
		DBR 0184-3G	60184 60184G	DBR 0184-3D	60184 60184D
		DBR 0184-LTG	60184 60184G	DBR 0184-LTD	60184 60184D
19	Amazone	DLM 7022-3G	P600NP004 (ENERGIE)	DLM 7022-3D	P600NP004 (ENERGIE)
		DLM 7022G	P600NP004 (ENERGIE)	DLM 7022D	P600NP004 (ENERGIE)
		DLM 7022-LTG	P600NP004 (ENERGIE)	DLM 7022-LTD	P600NP004 (ENERGIE)
20	Breviglieri	DFA 0129-3G	540129 540130	DFA 0129-3D	540129 540130
		DFA 0129G	540129 540130	DFA 0129D	540129 540130
		DMA 0006-3G	512075	DMA 0006-3D	512076
21	Celli	DMA 0006G	512075	DMA 0006D	512076
		DMA 0007-3G	7U00007	DMA 0007-3D	7U00006
		DMA 0007G	7U00007	DMA 0007D	7U00006
22	Falci	DMA 0007-LTG	7U00007	DMA 0007-LTD	7U00006
		DVC 0008-3G	7U00009	DVC 0008-3D	7U00008
		DVC 0008G	7U00009	DVC 0008D	7U00008
23	Ferraboli	DFO 1001G	RLM71001 RH77	DFO 1001D	RLM71001 RH77
		DFO 1001-3G	RLM71001 RH77	DFO 1001-3D	RLM71001 RH77
		DFO 8001G	RLM58001 RH78	DFO 8001D	RLM58001 RH78
24	Ferraboli	DFO 8001-3G	RLM58001 RH78	DFO 8001-3D	RLM58001 RH78
		DFO 8005G	RLM58005	DFO 8005D	RLM58005
		DFO 8005-3G	RLM58005	DFO 8005-3D	RLM58005
25	Ferraboli	DKU 2590-3G	00384025 00385731	DKU 2590-3D	00384026 00385730
		DKU 2590G	00384025 00385731	DKU 2590D	00384026 00385730
		DKU 2590-LTG	00384025 00385731	DKU 2590-LTD	00384026 00385730
26	Forigo	DHO 2937-3G	182937 182935	DHO 2937-3D	182938 182936
		DHO 2937G	182937 182935	DHO 2937D	182938 182936
		DHO 2937-3G	182937 182935	DHO 2937-3D	182938 182936
27	Forigo	DHO 2937G	182937 182935	DHO 2937D	182938 182936
		DHO 2937-3G	182937 182935	DHO 2937-3D	182938 182936
		DHO 2937G	182937 182935	DHO 2937D	182938 182936
28	Forigo	DHO 2937-3G	182937 182935	DHO 2937-3D	182938 182936
		DHO 2937G	182937 182935	DHO 2937D	182938 182936
		DHO 2937-3G	182937 182935	DHO 2937-3D	182938 182936
29	Horsch	DHO 2937-3G	182937 182935	DHO 2937-3D	182938 182936
		DHO 2937G	182937 182935	DHO 2937D	182938 182936
		DHO 2937-3G	182937 182935	DHO 2937-3D	182938 182936
30	Howard	DHO 2937-3G	182937 182935	DHO 2937-3D	182938 182936
		DHO 2937G	182937 182935	DHO 2937D	182938 182936
		DHO 2937-3G	182937 182935	DHO 2937-3D	182938 182936

31 **DH02939**   DH02939-3D 



				
330	100	15	60	BTHEX1460-NYEM
				€
DH02939G		DH02939D		53,35
DH02939-3G		DH02939-3D		73,91



DH02939-3D 

36 **DKU0394**   DKU0394-3D 











				
300	110	16	70	BTHEX1660-150-NYEM
				€
DKU0394G		DKU0394D		52,07
DKU0394-3G		DKU0394-3D		70,00
DKU0394-LTG		DKU0394-LTD		76,84



DKU0394-3D  DKU0394-LTD 

32 **DH05505**   DH05505-3D 











				
310	100	15	60	BTHEX1670-150-NYEM
				€
DH05505G		DH05505D		52,07
DH05505-3G		DH05505-3D		70,00



DH05505-3D 

37 **DKU0494**   DKU0494-3D 











				
265	110	12	70	BTHEX1660-150-NYEM
				€
DKU0494G		DKU0494D		52,06
DKU0494-3G		DKU0494-3D		70,01

DKU0494-3D 

33 **DH05598**   DH05598-3D 



				
330	100	15	60	Ø 20 mm
				€
DH05598G		DH05598D		52,07
DH05598-3G		DH05598-3D		70,00



DH05598-3D 

38 **DKU0964**   DKU0964-3D 











				
325	110	25	/	Ø 18 mm
				€
DKU0964G		DKU0964D		55,65
DKU0964-3G		DKU0964-3D		73,60
DKU0964-LTG		DKU0964-LTD		80,80
DKU0964-0G		DKU0964-0D		59,24
DKU0964-03G		DKU0964-03D		77,18



DKU0964-3D  DKU0964-LTD 

34 **DKU0204-0**   DKU0204-03D 











				
320	110	19	/	Ø 18 mm
				€
DKU0204-0G		DKU0204-0D		61,02
DKU0204-03G		DKU0204-03D		77,18



DKU0204-03D 

39 **DKU2050-0**   DKU2050-03D 











				
370	120	17	/	Ø 20 mm
				€
DKU2050-0G		DKU2050-0D		61,03
DKU2050-03G		DKU2050-03D		77,18



DKU2050-03D 

35 **DKU0254-0**   DKU0254-03D 











				
315	110	21	/	Ø 18 mm
				€
DKU0254-0G		DKU0254-0D		59,24
DKU0254-03G		DKU0254-03D		77,18

DKU0254-03D 

40 **DKU2100**  DKU2100-3 



				
360	40	27	/	Ø 16 mm
				€
DKU2100				52,07
DKU2100-3				70,00

DKU2100 

41 DKU2520F-0  **DKU2520F-03D** 



				
320	120	16	/	Ø 20 mm
				€
DKU2520F-0G		DKU2520F-0D		59,24
DKU2520F-03G		DKU2520F-03D		77,18
DKU2520F-0LTG		DKU2520F-0LTD		84,73

DKU2520F-03D DKU2520F-0LTD 

42 DKU2520-0  **DKU2520-03D** 



				
320	120	16	/	Ø 20 mm
				€
DKU2520-0G		DKU2520-0D		59,24
DKU2520-03G		DKU2520-03D		77,18
DKU2520-0LTG		DKU2520-0LTD		84,73

DKU2520-03D DKU2520-0LTD 

43 DKU2570  **DKU2570-3D** 



				
290	110	14	/	Ø 20 mm
				€
DKU2570G		DKU2570D		52,07
DKU2570-3G		DKU2570-3D		70,00
DKU2570-LTG		DKU2570-LTD		76,84



DKU2570-3D DKU2570-LTD 

44 DKU2590  **DKU2590-3D** 











				
315	120	16	/	Ø 20 mm
				€
DKU 2590G		DKU 2590D		52,07
DKU2590-3G		DKU2590-3D		70,00
DKU 2590-LTG		DKU 2590-LTD		76,84



DKU2590-3D 

45 DKU3700  **DKU3700-3** 



				
320	50	17	/	Ø 16 mm
				€
DKU3700				52,07
DKU3700-3				70,00

DKU3700 

CORRESPONDANCE CORRESPONDENCIA KORRESPONDENZ CORRESPONDENCE					
					
N°	TYPE I TIP I TYP	AGRICARB	ORIGINE	AGRICARB	ORIGINE
31	Howard	DHO 2939-3G	182940	DHO 2939-3D	182939
		DHO 2939G	182940	DHO 2939D	182939
		DHO 5505-3G	185506	DHO 5505-3D	185505
		DHO 5505G	185506	DHO 5505D	185505
		DHO 5598-3G	185598	DHO 5598-3D	185599
32	Howard	DHO 5598G	185598	DHO 5598D	185599
		DKU 0204-03G	526205	DKU 0204-03D	526204
		DKU 0204-0G	526205	DKU 0204-0D	526204
		DKU 0254-03G	526254	DKU 0254-03D	526255
		DKU 0254-0G	526254	DKU 0254-0D	526255
33	Howard	DKU 0394-3G	525395	DKU 0394-3D	525394
		DKU 0394G	525395	DKU 0394D	525394
		DKU 0394-LTG	525394	DKU 0394-LTD	525394
		DKU 0494-3G	525495	DKU 0494-3D	525494
		DKU 0494G	525495	DKU 0494D	525494
34	Howard	DKU 0964-3G	525965	DKU 0964-3D	525964
		DKU 0964G	525965	DKU 0964D	525964
		DKU 0964-03G	525965	DKU 0964-03D	525964
		DKU 0964-0G	525965	DKU 0964-0D	525964
		DKU 0964-LTG	525966	DKU 0964-LTD	525967
35	Howard	DKU 2050-03G	K2502050 526205	DKU 2050-03D	K2502040 526204
		DKU 2050-0G	K2502050 526205	DKU 2050-0D	K2502040 526204
		DKU 2100	5282100	DKU 2100	5282100
		DKU 2100-3	5282100	DKU 2100-3	5282100
		DKU 2520F-03G	2501120	DKU 2520F-03D	2501130
36	Howard	DKU 2520F-0G	2501120	DKU 2520F-0D	2501130
		DKU 2520F-0LTG	2501120	DKU 2520F-0LTD	2501130
		DKU 2520-03G	2501120	DKU 2520-03D	2501130
		DKU 2520-0G	2501120	DKU 2520-0D	2501130
		DKU 2520-0LTG	2501130	DKU 2520-0LTD	2501130
37	Howard	DKU 2570-3G	2500080 2500290 2500281 2502270	DKU 2570-3D	2500070 2500280 2500271 2502260
		DKU 2570G	2500080 2500290 2500281 2502270	DKU 2570D	2500070 2500280 2500271 2502260
		DKU 2570-LTG	2500080 2500290 2500281 2502270	DKU 2570-LTD	2500070 2500280 2500271 2502260
		DKU 2590-3G	2500100 2502250	DKU 2590-3D	2500090 2502240
		DKU 2590G	2500100 2502250	DKU 2590D	2500090 2502240
38	Howard	DKU 2590-LTG	2500100 2502250	DKU 2590-LTD	2500090 2502240
		DKU 3700	52503700	DKU 3700	52503700
		DKU 3700-3	52503700	DKU 3700-3	52503700
		DKU 2520F-03G	2501120	DKU 2520F-03D	2501130
		DKU 2520F-0G	2501120	DKU 2520F-0D	2501130
39	Howard	DKU 2520F-0LTG	2501120	DKU 2520F-0LTD	2501130
		DKU 2520-03G	2501120	DKU 2520-03D	2501130
		DKU 2520-0G	2501120	DKU 2520-0D	2501130
		DKU 2520-0LTG	2501130	DKU 2520-0LTD	2501130
		DKU 2570-3G	2500080 2500290 2500281 2502270	DKU 2570-3D	2500070 2500280 2500271 2502260
40	Howard	DKU 2570G	2500080 2500290 2500281 2502270	DKU 2570D	2500070 2500280 2500271 2502260
		DKU 2570-LTG	2500080 2500290 2500281 2502270	DKU 2570-LTD	2500070 2500280 2500271 2502260
		DKU 2590-3G	2500100 2502250	DKU 2590-3D	2500090 2502240
		DKU 2590G	2500100 2502250	DKU 2590D	2500090 2502240
		DKU 2590-LTG	2500100 2502250	DKU 2590-LTD	2500090 2502240
41	Howard	DKU 3700	52503700	DKU 3700	52503700
		DKU 3700-3	52503700	DKU 3700-3	52503700



46 DKU7070-0   **DKU7070-03D** 



				
345	110	18	/	Ø 20 mm
				€
DKU7070-0G	DKU7070-0D	59,24		
DKU7070-03G	DKU7070-03D	77,43		
DKU7070-0LTG	DKU7070-0LTD	84,73		

DKU7070-03D DKU7070-0LTD 

51 DKV6150   **DKV6150-3D** 



				
330	100	15	/	Ø 18 mm
				€
DKV6150G	DKV6150D	59,24		
DKV6150-3G	DKV6150-3D	77,18		
DKV6150-LTG	DKV6150-LTD	84,73		

DKV6150-3D DKV6150-LTD 



TT1830, Advance

47 DKU8380-0   **DKU8380-03D** 









				
315	110	16		Ø16
				€
DKU8380-0G	DKU8380-0D	59,24		
DKU8380-03G	DKU8380-03D	77,18		
DKU8380-0LTG	DKU8380-0LTD	84,73		

DKU8380-0D DKU8380-0LTD 

52 DLE1118   **DLE1118-3D** 



				
345	70	60	/	Ø 22 mm
				€
DLE1118G	DLE1118D	52,07		
DLE1118-3G	DLE1118-3D	70,00		



DLE1118-3D

48 DKV0018   **DKV0018-3D** 









				
330	110	18	50	BTHX1860-150-NY
				€
DKV0018G	DKV0018D	52,07		
DKV0018-3G	DKV0018-3D	70,00		



DKV0018-3D

53 DLE2200   **DLE2200-3** 









				
340	0	0	/	/
				€
DLE2200				52,07
DLE2200-3				70,00

DLE2200

49 DKV0146   **DKV0146-3D** 



				
280	90	12	50	Ø 16 mm
				€
DKV0146G	DKV0146D	52,07		
DKV0146-3G	DKV0146-3D	70,00		

DKV0146-3D

54 DLM7012   **DLM7012-3D** 



				
310	110	18	70	Ø 20 mm
				€
DLM7012G	DLM7012D	55,65		
DLM7012-3G	DLM7012-3D	73,60		
DLM7012-LTG	DLM7012-LTD	80,80		

DLM7012-3D DLM7012-LTD 

Zirkon 6, Zirkon 9, Zirkon 12

50 DKV4150   **DKV4150-3D** 



				
330	100	18	/	Ø 18 mm
				€
DKV4150G	DKV4150D	59,24		
DKV4150-3G	DKV4150-3D	77,18		
DKV4150-LTG	DKV4150-LTD	84,73		

DKV4150-3D DKV4150-LTD 

TT2530, Elit

55 DLM7022   **DLM7022-3D** 



				
310	110	15	70	BTHX1660-150-NYEM
				€
DLM7022G	DLM7022D	55,65		
DLM7022-3G	DLM7022-3D	73,60		
DLM7022-LTG	DLM7022-LTD	80,80		

DLM7022-3D DLM7022-LTD 

Zirkon 7, Energy

56 DLM7048L-0   **DLM7048L-03D** 





				
340	100	18	/	/
				€
DLM7048L-0G	DLM7048L-0D			71,21
DLM7048L-03G	DLM7048L-03D			89,15
DLM7048L-0LTG	DLM7048L-0LTD			97,87
 Zirkon 10				



57 DLM7048-0   **DLM7048-03D** 



				
310	100	18	/	/
				€
DLM7048-0G	DLM7048-0D			71,21
DLM7048-03G	DLM7048-03D			89,15
DLM7048-0LTG	DLM7048-0LTD			97,87
 Zirkon 10				

58 DLM7058-0   **DLM7058-03D** 



				
320	100	16	/	/
				€
DLM7058-0G	DLM7058-0D			71,21
DLM7058-03G	DLM7058-03D			89,15
 Zirkon 8				

59 DLM7110L-0   **DLM7110L-03D** 





				
340	100	19	/	/
				€
DLM7110L-03G	DLM7110L-03D			89,15
DLM7110L-0LTG	DLM7110L-0LTD			97,87
 Zirkon 12				









60 DLM7110-0   **DLM7110-03D** 



				
320	100	19	/	/
				€
DLM7110-0G	DLM7110-0D			71,21
DLM7110-03G	DLM7110-03D			89,15
DLM7110-0LTG	DLM7110-0LTD			97,87
 Zirkon 12				



CORRESPONDANCE CORRESPONDENCIA KORRESPONDENZ CORRESPONDENCE							
		<		>			
N°	TYPE TIP TYP	AGRICARB	ORIGINE	AGRICARB	ORIGINE		
46	Kuhn-Huurd	DKU 7070-03G	2507080	DKU 7070-03D	2507070		
		DKU 7070-0G	2507080	DKU 7070-0D	2507070		
		DKU 7070-0LTG	2507080	DKU 7070-0LTD	2507070		
		DKU 8380-0G	K2518380 K2512390	DKU 8380-0D	K2518370 K2512380		
47	Kuhn-Huurd	DKU 8380-03G	K2518380 K2512390	DKU 8380-03D	K2518370 K2512380		
		DKU 8380-0LTG	K2518380 K2512390	DKU 8380-0LTD	K2518370 K2512380		
		48	Kverneland-Maletti	DKV 0018-3G	MAE030146 MAE040146	DKV 0018-3D	MAE030146 MAE040146
				DKV 0018G	MAE030146 MAE040146	DKV 0018D	MAE030146 MAE040146
49	Kverneland-Maletti	DKV 0146-3G	MAE020146	DKV 0146-3D	MAE010146		
		DKV 0146G	MAE020146	DKV 0146D	MAE010146		
50	Kverneland-Maletti	DKV 4150-3G	44000151 44010151	DKV 4150-3D	44000150 44010150		
		DKV 4150G	44000151 44010151	DKV 4150D	44000150 44010150		
		DKV 4150-LTG	44000151 44010151	DKV 4150-LTD	44000150 44010150		
		DKV 6150-3G	46010151 46000151	DKV 6150-3D	46010150 46000150		
51	Kverneland-Maletti	DKV 6150G	46010151 46000151	DKV 6150D	46010150 46000150		
		DKV 6150-LTG	46010151 46000151	DKV 6150-LTD	46010150 46000150		
52	Lely	DLE 1118-3G	116990111	DLE 1118-3D	116990112		
		DLE 1118G	116990111	DLE 1118D	116990112		
		DLE 2200	1169902200	DLE 2200	1169902200		
53	Lely	DLE 2200-3	1169902200	DLE 2200-3	1169902200		
		54	Lemken	DLM 7012-3G	3377013 3377033	DLM 7012-3D	3377012 3377032
				DLM 7012G	3377013 3377033	DLM 7012D	3377012 3377032
55	Lemken	DLM 7012-LTG	3377013 3377033	DLM 7012-LTD	3377012 3377032		
		DLM 7022-3G	3377023	DLM 7022-3D	3377022		
56	Lemken	DLM 7022G	3377023	DLM 7022D	3377022		
		DLM 7022-LTG	3377022	DLM 7022-LTD	3377022		
57	Lemken	DLM 7048L-03G	3377049 3377051	DLM 7048L-03D	3377048 3377050		
		DLM 7048L-0G	3377049 3377051	DLM 7048L-0D	3377048 3377050		
		DLM 7048L-0LTG	3377049 3377051	DLM 7048L-0LTD	3377048 3377050		
		DLM 7048-03G	3377049	DLM 7048-03D	3377048		
58	Lemken	DLM 7048-0G	3377049	DLM 7048-0D	3377048		
		DLM 7048-0LTG	3377048	DLM 7048-0LTD	3377048		
59	Lemken	DLM 7058-03G	3377059	DLM 7058-03D	3377058		
		DLM 7058-0G	3377059	DLM 7058-0D	3377058		
60	Lemken	DLM 7110L-03G	33710010	DLM 7110L-03D	33710011		
		DLM 7110L-0LTG	33710010	DLM 7110L-0LTD	33710011		
60	Lemken	DLM 7110-03G	33710010	DLM 7110-03D	33710011		
		DLM 7110-0G	33710010	DLM 7110-0D	33710011		
60	Lemken	DLM 7110-LTG	33710010	DLM 7110-LTD	33710011		
		DLM 7110-0LTG	33710010	DLM 7110-0LTD	33710011		







61 DMA0006   [DMA0006-3D](#) 

				
280	90	15	50	BTHX1660-150-NYEM
				€
DMA0006G		DMA0006D		52,07
DMA0006-3G		DMA0006-3D		70,00
				

DMA0006-3D

Diamente, Master

66 DMA0252-0   [DMA0252-03D](#) 

				
320	100	16	/	
				€
DMA0252-0G		DMA0252-0D		59,24
DMA0252-03G		DMA0252-03D		77,18
				

DMA0252-03D

Toro HD, Orso HD, Jumbo HD

62 DMA0007   [DMA0007-3D](#) 

				
280	100	15	60	BTHX1660-150-NYEM
				€
DMA0007G		DMA0007D		52,07
DMA0007-3G		DMA0007-3D		70,00
DMA0007-LTG		DMA0007-LTD		76,84
				

DMA0007-3D



LT









67 DP04002-0   [DP04002-03D](#) 

				
300	110	15		Ø 26 mm
				€
DP04002-0G		DP04002-0D		59,24
DP04002-03G		DP04002-03D		77,18
DP04002-0LTG		DP04002-0LTD		84,73
				

DP04002-03D DP04002-0LTD



LT









63 DMA0008   [DMA0008-3D](#) 

				
325	120	16	70	Ø 18 mm
				€
DMA0008G		DMA0008D		52,07
DMA0008-3G		DMA0008-3D		70,00
				



DMA0008-3D









Mega

68 DP00120   [DP00120-3D](#) 

				
330	110	18	/	/
				€
DP00120G		DP00120D		59,24
DP00120-3G		DP00120-3D		77,18
				

DP00120-3D

64 DMA0009-0   [DMA0009-03D](#) 

				
325	100	15	/	
				€
DMA0009-0G		DMA0009-0D		59,24
DMA0009-03G		DMA0009-03D		77,18
				

DMA0009-03D

DM, Aquila, Mega, Toro, Jumbo



69 DP00220   [DP00220-3D](#) 









				
330	110	18	/	Ø 26 mm
				€
DP00220G		DP00220D		59,24
DP00220-3G		DP00220-3D		77,18
DP00220-LTG		DP00220-LTD		84,73
				

DP00220-3D DP00220-LTD

LT



Lion









65 DMA0159-0   [DMA0159-03D](#) 

				
340	100	12	60	BTHX1660-150-NYEM
				€
DMA0159-0G		DMA0159-0D		52,07
DMA0159-03G		DMA0159-03D		70,00
DMA0159-0LTG		DMA0159-0LTD		76,84
				

DMA0159-03D

LT

70 DKG0026   [DKG0026-3D](#) 

				
275	80	18	40	BTHX1460-NYEM
				€
DKG0026G		DKG0026D		52,07
DKG0026-3G		DKG0026-3D		70,00
				

DKG0026-3D

71 DKG0030 **DKG0030-3D**

290	100	18	65	BTHEX1660-150-NYEM
				€
DKG0030G		DKG0030D		52,07
DKG0030-3G		DKG0030-3D		70,00
DKG0030-LTG		DKG0030-LTD		76,84

DKG0030-3D DKG0030-LTD

72 DKG0034 **DKG0034-3D**

320	95	16	/	Ø 30 mm
				€
DKG0034G		DKG0034D		55,65
DKG0034-3G		DKG0034-3D		73,60

DKG0034-3D

73 DKG4166 **DKG4166-3D**

325	100	18	65	BTHEX1660-150-NYEM
				€
DKG4166G		DKG4166D		55,65
DKG4166-3G		DKG4166-3D		73,60

DKG4166-3D

74 DKG4170 **DKG4170-3D**

325	100	18	70	BTHEX1660-150-NYEM
				€
DKG4170G		DKG4170D		55,65
DKG4170-3G		DKG4170-3D		73,60

DKG4170-3D

CORRESPONDANCE | CORRESPONDENCIA | KORRESPONDENZ | CORRESPONDENCE

N°	TYPE TIP TYP	AGRICARB	ORIGINE	AGRICARB	ORIGINE
61		DMA 0006-3G	27100209	DMA 0006-3D	27100210
		DMA 0006G	27100209	DMA 0006D	27100210
62		DMA 0007-3G	36100211	DMA 0007-3D	36100210
		DMA 0007G	36100211	DMA 0007D	36100210
63		DMA 0007-LTG	36100211	DMA 0007-LTD	36100210
		DMA 0008-3G	61100230	DMA 0008-3D	61100229
64	Maschio	DMA 0008G	61100230	DMA 0008D	61100229
		DMA 0009-03G	36100367 M36100367R	DMA 0009-03D	36100366 M36100366R
65		DMA 0009-0G	36100367 M36100367R	DMA 0009-0D	36100366 M36100366R
		DMA 0159-03G	M36100160	DMA 0159-03D	M36100159
66		DMA 0159-0G	M36100160	DMA 0159-0D	M36100159
		DMA0159-0LTG	M36100161	DMA0159-0LTD	M36100162
67	Pottinger	DMA 0252-03G	36100367 M36100253	DMA 0252-03D	36100366 M36100252
		DMA 0252-0G	36100367 M36100253	DMA 0252-0D	36100366 M36100252
68		DPO 4002-03G	8723400200	DPO 4002-03D	8723400250
		DPO 4002-0G	8723400200	DPO 4002-0D	8723400250
69		DPO 4002-0LTG	8723400200	DPO 4002-0LTD	8723400250
		DPO 0120-3G	00873401250	DPO 0120-3D	00873401200
70		DPO 0120G	00873401250	DPO 0120D	00873401200
		DPO 0220-3G	0087340225	DPO 0220-3D	0087340220
71	Rabewerk	DPO 0220G	0087340225	DPO 0220D	0087340220
		DPO 0220-LTG	0087340220	DPO 0220-LTD	0087340220
72		DKG 0026-3G	84091202	DKG 0026-3D	84091201
		DKG 0026G	84091202	DKG 0026D	84091201
73		DKG 0030-3G	84045002	DKG 0030-3D	84045001
		DKG 0030G	84045002	DKG 0030D	84045001
74		DKG 0030-LTG	84045001	DKG 0030-LTD	84045001
		DKG 0034-3G	84377702	DKG 0034-3D	84377701
75		DKG 0034G	84377702	DKG 0034D	84377701
		DKG 4166-3G	84231803	DKG 4166-3D	84231801
76		DKG 4166G	84231803	DKG 4166D	84231801
		DKG 4170-3G	84231802	DKG4170D	84231804
77		DKG 4170G	84231802	DKG 4170D	84231804

75 DKV4150   **DKV4150-3D** 

				
330	100	18	/	Ø 18 mm
				€
DKV4150G		DKV4150D		59,24
DKV4150-3G		DKV4150-3D		77,18
DKV4150-LTG		DKV4150-LTD		84,73

DKV4150-3D  DKV4150-LTD

TT2530, Elit

80 DHS0320-O   **DHS0320-03D** 

				
340	100	18	/	Ø 18 mm
				€
DHS0320-0G		DHS0320-0D		71,21
DHS0320-03G		DHS0320-03D		89,15
DHS0320-0LTG		DHS0320-0LTD		97,87



DHS0320-03D  DHS0320-0LTD







76 DKV6150   **DKV6150-3D** 

				
330	100	15	/	Ø 18 mm
				€
DKV6150G		DKV6150D		59,24
DKV6150-3G		DKV6150-3D		77,18
DKV6150-LTG		DKV6150-LTD		84,73



DKV6150-3D  DKV6150-LTD







TT1830, Advance

81 DLE1118   **DLE1118-3D** 

				
345	70	60	/	Ø 22 mm
				€
DLE1118G		DLE1118D		52,07
DLE1118-3G		DLE1118-3D		70,00



DLE1118-3D







77 DMA0006   **DMA0006-3D** 

				
280	90	15	50	BTHEX1660-150-NYEM
				€
DMA0006G		DMA0006D		52,07
DMA0006-3G		DMA0006-3D		70,00

DMA0006-3D



Diamante, Master







83 DVC0008   **DVC0008-3D** 

				
310	110	15	60	BTHEX2060-150-NY
				€
DVC0008G		DVC0008D		52,83
DVC0008-3G		DVC0008-3D		71,05

DVC0008-3D

Top

78 DHS0146-O   **DHS0146-03D** 



				
330	110	15	65	BTHEX1660-150-NYEM
				€
DHS0146-0G		DHS0146-0D		59,24
DHS0146-03G		DHS0146-03D		77,18







DHS0146-03D

85 DMA0007   **DMA0007-3D** 

				
280	100	15	60	BTHEX1660-150-NYEM
				€
DMA0007G		DMA0007D		52,07
DMA0007-3G		DMA0007-3D		70,00
DMA0007-LTG		DMA0007-LTD		76,84

DMA0007-3D  DMA0007-LTD

79 DHS0308-O   **DHS0308-03D** 

				
320	100	19	/	/
				€
DHS0308-0G		DHS0308-0D		71,21
DHS0308-03G		DHS0308-03D		89,15

DHS0308-03D



CORRESPONDANCE CORRESPONDENCIA KORRESPONDENZ CORRESPONDENCE					
		<		>	
N°	TYPE TIP TYP	AGRICARB	ORIGINE	AGRICARB	ORIGINE
75	Rau	DKV 4150-3G		DKV 4150-3D	
		DKV 4150G		DKV 4150D	
		DKV 4150-LTG		DKV 4150-LTD	
76	Rau	DKV 6150-3G		DKV 6150-3D	
		DKV 6150G		DKV 6150D	
		DKV 6150-LTG		DKV 6150-LTD	
77		DMA 0006-3G	44501	DMA 0006-3D	44502
		DMA 0006G	44501	DMA 0006D	44502
78		DHS 0146-03G	980145 680131	DHS 0146-03D	980146 680132
		DHS 0146-0G	980145 680131	DHS 0146-0D	980146 680132
79	Sulky	DHS 0308-03G	980309 980316	DHS 0308-03D	980308 980317
		DHS 0308-0G	980309 980316	DHS 0308-0D	980308 980317
		DHS 0320-03G	980320 680320	DHS 0320-03D	980319 680319
80		DHS 0320-0G	980320 680320	DHS 0320-0D	980319 680319
		DHS 0320-0LTG	980319	DHS 0320-0LTD	980320
81	Tulip	DLE 1118-3G	116990111	DLE 1118-3D	116990112
		DLE 1118G	116990111	DLE 1118D	116990112
77	Vicon	DMA 0006-3G	7U007	DMA 0006-3D	7U007
		DMA 0006G	7U007	DMA 0006D	7U007
		DVC 0008-3G	7U00009	DVC 0008-3D	7U00008
83		DVC 0008G	7U00009	DVC 0008D	7U00008
		DMA 0006-3G		DMA 0006-3D	
77	Vogel & Noot	DMA 0006G		DMA 0006D	
		DMA 0007-3G		DMA 0007-3D	
		DMA 0007G		DMA 0007D	
85		DMA 0007-LTG		DMA 0007-LTD	

Prestation de rechargement

Welding service / Schweissleistungen / Prestación de soldadura

PSHERS PSHERS 3
Prestation de soudage sur support externe. RPM non inclus

Cut + Weld (only service)
Schneiden + Anschweißen (nur Leistungen).
Recorte + Refuerzo para diente del cliente (unicamente prestación).

	€
PSHERS	12,52
PSHERS-3	18,86

PSRDH 90
PSRDH 135
Rechargement sur dent 2-3 plaquettes







Harfacing on tires 2-3 plattens
Hartauftrag auf zinken 2-3 platten
Refuerzo suplementario para 2-3 plaquetas

	€
PSRDH-90	10,09
PSRDH-135	14,68

Retrouvez toutes nos prestations page 160 | Find out about all our services on page 160 | Informieren Sie sich über alle unsere Dienstleistungen auf Seite 160 | Descubra todos nuestros servicios en la página 160.

1 **HEBR0490** 









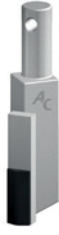

				
500	108	7		
				€
HEBR0490				10,08

HEBR0490 

6 **DRA3024** 











				
175	30	30	/	Ø 10 mm
				€
DRA3024				28,17

DRA3024 

2 **HECA0307** 











				
650	90	7		
				€
HECA0307				20,74

HECA0307 

7 **HEGU0110** 











				
537	220	12		
				€
HEGU0110				28,43

HEGU0110 

3 **HECA0317** 











				
520	90	7		
				€
HECA0317				20,74

HECA0317 

8 **HEHA9312** 











				
485	48	7		
				€
HEHA9312				14,22

HEHA9312 

4 **HEEI5002** 











				
495	7	7		
				€
HEEI5002				14,22

HEEI5002 **Aerostar** 

9 **ROLH3828** 











				
250	60	12	/	Ø 16 mm
				€
ROLH3829-HRG ROLH3829-HRD				17,82

ROLH3829-HRD 

5 **DRA0025** 











				
175	25	25	/	Ø 10 mm
				€
DRA0025				28,17

DRA0025 

10 **ROVH3901** 



				
213	124	7	57	Ø 12 mm
				€
ROVH3900-HRG ROVH3901-HRD				17,82

ROVH3901-HRD 

11 ROVH9901



ROVH9901-HRD

203	127	7	57	Ø 10 mm
				€
ROVH9900-HRG		ROVH9901-HRD		17,82

12 ROVH9948



ROVH9948-HRG

205	80	7	57	Ø 13,5 mm
				€
ROVH9948-HRG		ROVH9949-HRD		17,82

13 HEK05380



HEK05380

750	227	13,5		
				€
HEK05380				41,28

14 SCK0552-TH



SCK0552-TH

167	110	5	40	BTFC1250
				€
SCK0552-TH				44,65

Vibroflex









CORRESPONDANCE | CORRESPONDENCIA | KORRESPONDENZ | CORRESPONDENCE

N°	TYPE TIP TYP	AGRICARB	ORIGINE	AGRICARB	ORIGINE
1	Breton	HEBR 0490		HEBR 0490	
2	Carré	HECA 0307	50400307	HECA 0307	50400307
3		HECA 0317	50400317	HECA 0317	50400317
4	Einbock	HEEI 5002	15002	HEEI 5002	15002
5	Falc	DRA 0025	240131	DRA 0025	240131
6		DRA 3024	35920	DRA 3024	35920
7	Güttler	HEGU 0110	72000110	HEGU 0110	72000110
8	Hatzenbichler	HEHA 9312	9312	HEHA 9312	9312
9	Howard	ROLH 3828-HRG	73000653829V	ROLH 3829-HRD	73000653828V
10		ROVH 3900-HRG	73000103900 63592	ROVH 3901-HRD	73000103901 63593
11		ROVH 9900-HRG	73000009900	ROVH 9901-HRD	73000009901
12		ROVH 9948-HRG	9948 9930 73000009948V	ROVH 9949-HRD	9949 9931 73000009949V
13	Köckerling	HEKO 5380	905380	HEKO 5380	905380
14	Kongskilde- New Holland	SCK 0552-TH	101000552 101000915	SCK 0552-TH	101000552 101000915





15 ROLK2800 











				
226	60	15	/	Ø 16 mm
				€
ROLK2800-HRG	ROLK2810-HRD			17,82
				

ROLK2810-HRD

20 ROVM0426 











				
215	80	8	55	Ø14
				€
ROVM0427-HRG	ROVM0426-HRD			17,82
				

ROVM0426-HRD
C Type, Puma, SC type

16 ROLK3600 











				
290	60	15	/	Ø 7,5 mm
				€
ROLK3700-HRG	ROLK3600-HRD			17,82
				

ROLK3600-HRD

21 ROVM0428 











				
224	80	8	55	Ø 14 mm
				€
ROVM0429-HRG	ROVM0428-HRD			17,82
				

ROVM0428-HRD
C Type, Puma, SC type

17 ROVK1600 











				
202	135	7	57	Ø 14 mm
				€
ROVK1600-HRG	ROVK1600-HRD			17,82
				

ROVK1600-HRD

22 ROVM0435 











				
260	144	10	56	Ø 14,5 mm
				€
ROVM0436-HRG	ROVM0435-HRD			31,69
				

ROVM0435-HRD

18 ROVK7000 











				
250	145	7	57	Ø 14 mm
				€
ROVK7000-HRG	ROVK7000-HRD			17,82
				

ROVK7000-HRD

23 ROVM8430 











				
175	80	6	55	Ø 14 mm
				€
ROVM8431-HRG	ROVM8430-HRD			17,82
				

ROVM8430-HRD

19 ROVK7510 











				
206	134	7	57	Ø 12 mm
				€
ROVK7610-HRG	ROVK7510-HRD			17,82
				

ROVK7510-HRD

24 DRA0025 



				
175	25	25	/	Ø 10 mm
				€
DRA0025				28,17
				

DRA0025

25 DRA3024



DRA3024

Q

175	30	30	/	Ø 10 mm
				€
DRA3024				29,21

26 DRA3028



DRA3028

Q

175	30	30	/	Ø 10 mm
				€
DRA3028				29,21

CORRESPONDANCE | CORRESPONDENCIA | KORRESPONDENZ | CORRESPONDENCE

		<		>	
N°	TYPE TIP TYP	AGRICARB	ORIGINE	AGRICARB	ORIGINE
15		ROLK 2800-HRG	K1602800	ROLK 2810-HRD	K1602810
16		ROLK 3700-HRG	K1603700	ROLK 3600-HRD	K1603600
17	Kuhn-Huard	ROVK 1500-HRG	51921500	ROVK 1600-HRD	51921600
18		ROVK 7100-HRG	51937100	ROVK 7000-HRD	51937000
19		ROVK 7610-HRG	52227610	ROVK 7510-HRD	52227510
20	Maschio	ROVM0427-HRG	M01110427	ROVM0426-HRD	M01110426
21		ROVM 0429-HRG	M01110429	ROVM 0428-HRD	M01110428
22		ROVM 0436-HRG	M741004356R	ROVM 0435-HRD	M74100435R
23		ROVM 8431-HRG	M02108431R	ROVM 8430-HRD	M02108430R
24		DRA 0025	23374	DRA 0025	23374
25	Rau-Sicam	DRA 3024	00035920	DRA 3024	00035920
26		DRA 3028	00049048	DRA 3028	00049048

Notes
Nota | notiz | note

27 SVI0030-R

Q Cintré-Cimbrado-Gewölbt-Curved



SVI0030-R

↕	↔	↗↘	↻	⊕
175	35	13		BTOCC1045EC
<		>		€
SVI0030-R		SVI0030-R		14,71

31 SVI5010

Q Cintré-Cimbrado-Gewölbt-Curved



SVI5010

↕	↔	↗↘	↻	⊕
263	50	15	35-60	BTFCC Ø 10 mm
<		>		€
SVI5010				46,17

28 SVI0030-XT

Q Cintré-Cimbrado-Gewölbt-Curved



SVI0030-XT

↕	↔	↗↘	↻	⊕
175	35	15		BTOCC1045EC
<		>		€
SVI0030-XT				18,63

32 SVI5012

Q Cintré-Cimbrado-Gewölbt-Curved



SVI5012

↕	↔	↗↘	↻	⊕
263	50	15	35-60	BTFCC Ø 12 mm
<		>		€
SVI5012				46,17

29 SVI1335P-HR

Q Plat-Llano-Flach-Flat



SVI1335P-HR

↕	↔	↗↘	↻	⊕
140	35	23	/	BTOCC1045EC
<		>		€
SVI1335P-HR		SVI1335P-HR		18,62

33 SVI6010

Q Cintré-Cimbrado-Gewölbt-Curved



SVI6010

↕	↔	↗↘	↻	⊕
263	60	24	35-60	BTFCC Ø 10 mm
<		>		€
SVI6010				59,24

30 SVI1835-HR

Q Cintré-Cimbrado-Gewölbt-Curved



SVI1835-HR

↕	↔	↗↘	↻	⊕
185	35	19	40-50	BTOCC Ø 10 mm
<		>		€
SVI1835-HR				19,89

34 SVI6012

Q Cintré-Cimbrado-Gewölbt-Curved



SVI6012

↕	↔	↗↘	↻	⊕
263	60	24	35-60	BTFCC Ø 12 mm
<		>		€
SVI6012				59,24

1 DPA0335-R



333	50	10	100	BTHEX1440-150-NYEM
				€
DPA0335-R				23,82

DPA0335-R

6 DPB0370-R



383	50	12	100	BTHEX1450-150-NY
				€
DPB0370-R				25,13

DPB0370-R

2 DPA0275-R



275	40	10	75	BTHEX1235-OB
				€
DPA0275-R				23,82

DPA0275-R

7 BGRA1967



200	100	12	75	BTFCC 012
				€
BGRA1967G	BGRA1967D			56,31

BGRA1967D
Bedformer, Billoneur

3 DPA0265-R



275	50	12	80	BTHEX1240-125-NY
				€
DPA0265-R				23,82

DPA0265-R

8 BGRS1966



375	130	12	70	BTF2E 012
				€
BGRS1966				233,53

BGRS1966
Bedformer, Billoneur

4 DPR0330-R



330	40	10	80	BTHEX1235-OB
				€
DPR0330-R				23,82

DPR0330-R

9 DPG0255-R



265	45	10	80	BTHEX1235-OB
				€
DPG0255-R				23,82

DPG0255-R

5 DPB0360-R



357	40	10	80	BTHEX1235-OB
				€
DPB0360-R				23,82

DPB0360-R

10 DPG0343-R



354	50	10	92	BTHEX1640-NY
				€
DPG0343-R				23,82

DPG0343-R

11 DPG0370-R



DPG0370-R

Q					
↕	↔	↔	↔	⊕	
384	50	12	100	BTHEX Ø 16 mm BTHEX Ø 14 mm	
				€	
DPG0370-R				25,13	

12 DPG0415-R



DPG0415-R

Q					
↕	↔	↔	↔	⊕	
440	60	12	120	BTHEX1640-NY	
				€	
DPG0415-R				27,41	

13 DPG9660-R



DPG9660-R

Q					
↕	↔	↔	↔	⊕	
219	50	12	50	BTHEX1640-NY	
				€	
DPG9660-R		DPG9660-R		27,41	

14 DPG0345-R



DPG0345-R

Q					
↕	↔	↔	↔	⊕	
342	45	10	80	BTHEX1235-OB	
				€	
DPG0345-R		DPG0345-R		23,82	

15 DPR0255-R



DPR0255-R

Q					
↕	↔	↔	↔	⊕	
260	40	10	80	BTHEX1235-OB	
				€	
DPR0255-R				23,82	

CORRESPONDANCE | CORRESPONDENCIA | KORRESPONDENZ | CORRESPONDENCE

		◀		▶	
N°	TYPE TIP TYP	AGRICARB	ORIGINE	AGRICARB	ORIGINE
1	Agrator	DPA 0335-R		DPA 0335-R	
2	Amac	DPA 0275-R	70020902	DPA 0275-R	70020902
3	AVR	DPA 0265-R	350401	DPA 0265-R	350401
4		DPR 0330-R	18198	DPR 0330-R	18198
5	Baselier	DPB 0360-R	900197 FK090041	DPB 0360-R	900197 FK090041
6		DPB 0370-R	FKS90001	DPB 0370-R	FKS90001
7		BGRA 1967G	8901968	BGRA 1967D	8901967
8		BGRS 1966	8901966	BGRS 1966	8901966
9	Grimme	DPG 0255-R		DPG 0255-R	
10		DPG 0343-R		DPG 0343-R	
11		DPG 0370-R	10061039	DPG 0370-R	10061039
12		DPG 0415-R	10067098	DPG 0415-R	10067098
13		DPG 9660-R	10089660 10089661	DPG 9660-R	10089660 10089661
14	Gruse	DPG 0345-R	10060817	DPG 0345-R	10060817
15	Rumptstad	DPR 0255-R	RS18198 RS18197	DPR 0255-R	RS18198 RS18197
4		DPR 0330-R	RS1898 RS1874	DPR 0330-R	RS1898 RS1874
16	Struick	DPS 0330-R		DPS 0330-R	
17		DPS 0380-R		DPS 0380-R	

16 DPS0330-R



DPS0330-R

Q					
↕	↔	↔	↔	⊕	
330	40	10	80	BTHEX1235-OB	
				€	
DPS0330-R		DPS0330-R		23,82	

17 DPS0380-R



DPS0380-R

Q					
↕	↔	↔	↔	⊕	
367	50	12	40-40	Ø 14 mm	
				€	
DPS0380-R				25,13	

1 GAG3500



200	95	5	35-135	Ø 10 mm	
				€	
GAG3500				24,40	

GAG3500

6 GAM0090

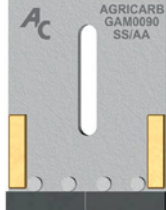

120	90	5	/	Ø 10 mm	
				€	
GAM0090				24,40	

GAM0090

2 GAL0080

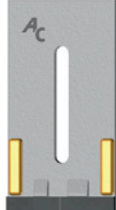

150	80	5	/	Ø 10 mm	
				€	
GAL0080				24,40	

GAL0080

7 GAM7074



80	50	4	/	Ø 10 mm	
				€	
GAM7074				22,30	

GAM7074

3 GAM0040



90	40	5	/	Ø 10 mm	
				€	
GAM0040				20,70	

GAM0040

Matrix

8 GBR0500



140	90	5	/	Ø 10 mm	
				€	
GBR0500				25,88	

GBR0500

4 GAM0055

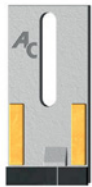

115	55	5	/	Ø 10 mm	
				€	
GAM0055				20,70	

GAM0055

9 GBR8975

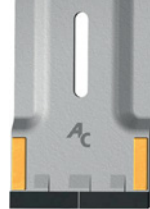

150	100	4	/	Ø 10 mm	
				€	
GBR8975				25,88	

GBR8975

5 GAM0085



100	85	5	/	Ø 10 mm	
				€	
GAM0085				24,40	

GAM0085

10 GDU0003

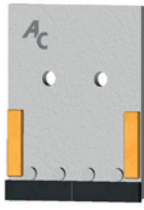

115	90	5	35	Ø 10 mm	
				€	
GDU0003				24,40	

GDU0003

11 GAM0090

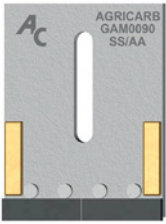

GAM0090

Q

↕	↔	↔	↔	⊕
120	90	5	/	Ø 10 mm
< >				€
GAM0090				24,40

12 GH00009

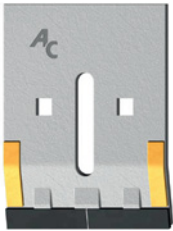

GH00009

Q

↕	↔	↔	↔	⊕
130	100	5	/	Ø 10 mm
< >				€
GH00009				24,40

13 GH06602



GH06602

Q

↕	↔	↔	↔	⊕
165	48	5	/	Ø 10 mm
< >				€
GH06602				20,70

CORRESPONDANCE | CORRESPONDENCIA | KORRESPONDENZ | CORRESPONDENCE

N°	TYPE TIP TYP	AGRICARB	ORIGINE	AGRICARB	ORIGINE
1	Agram	GAG 3500	123500	GAG 3500	123500
2	Alpego	GAL 0080	1308	GAL 0080	1308
3		GAM 0040	957147	GAM 0040	957147
4		GAM 0055	6040200	GAM 0055	6040200
5	Amazone	GAM 0085	960279	GAM 0085	960279
6		GAM 0090	6081200 6084200	GAM 0090	6081200 6084200
7		GAM 7074	967074	GAM 7074	967074
8		GBR 0500	060500	GBR 0500	060500
9	Breviglieri	GBR 8975	3178974	GBR 8975	3178974
10	Dutzi	GDU 0003	255038001	GDU 0003	255038001
11	Falc	GAM 0090	543001 6083200	GAM 0090	543001 6083200
12		GHO 0009	652882	GHO 0009	652882
13	Howard	GHO 6602	34306602	GHO 6602	34306602



HR2

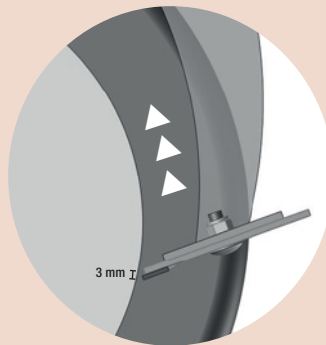

3 mm

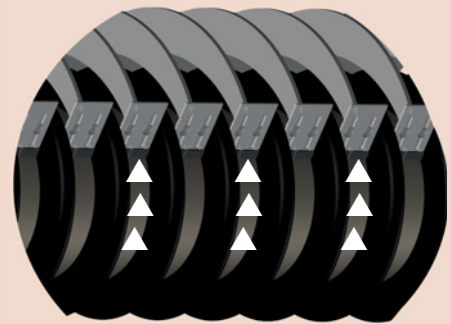

ADAPTEZ VOTRE PERÇAGE !

¡ POSIBILIDAD DE ADAPTAR SU PERFORACION ! GESTALTEN SIE DIE BOHRUNG INDIVIDUELL ! CUSTOMIZE THE DRILLING !

14 GK01201

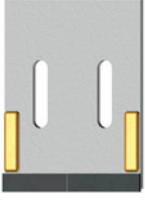

127	95	5	45	Ø 10 mm
				€
GK01201				20,70

GK01201

19 GKU0090

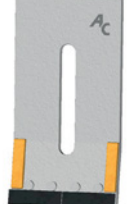

170	90	5	/	Ø 12 mm
				€
GKU0090				24,40

GKU0090

15 GKU0075

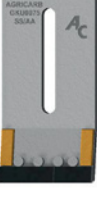

140	75	5	/	Ø 10 mm
				€
GKU0075				20,70

GKU0075

20 GKV0105

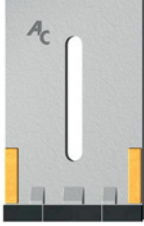

158	105	5	/	Ø 12 mm
				€
GKV0105				25,88

GKV0105

16 GKU0090



170	90	5	/	Ø 12 mm
				€
GKU0090				24,40

GKU0090

21 GLE0004

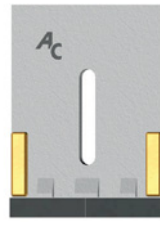

130	100	5	/	Ø 10 mm
				€
GLE0004				24,40

GLE0004

17 GKU5120



185	60	5	/	Ø 13 mm
				€
GKU5120				21,95

GKU5120

22 GLE102L

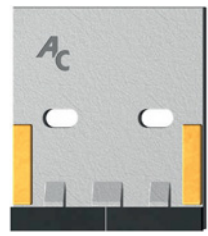

110	100	5	41-59	Ø 10 mm
				€
GLE102L				24,40

GLE102L

18 GKU5130



185	80	5	/	Ø 12 mm
				€
GKU5130				24,40

GKU5130

23 GLM0010

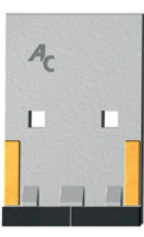

130	90	5	48	Ø 10 mm
				€
GLM0010				24,40

GLM0010

24 GLM2004

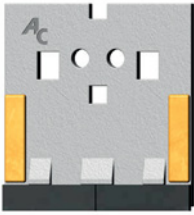

GLM2004

Q

94,5	90	5	48	Ø 12 mm
GLM2004				€ 24,40

25 GLM2005

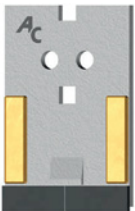

GLM2005

Q

94	60	5	17	Ø 8 mm
GLM2005				€ 20,70

26 GMA0095

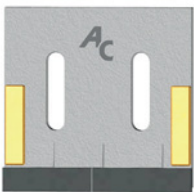

GMA0095

Q

90	95	5	43	Ø 8 mm
GMA0095				€ 24,40

27 GMA0667

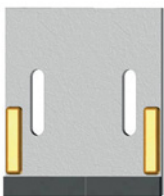

GMA0667

Q

110	95	5	56	Ø 8 mm
GMA0667				€ 24,40

28 GSU0100

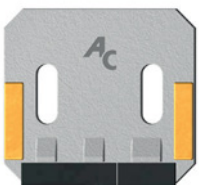

GSU0100

Q

100	90	5	55	Ø 10 mm
GSU0100				€ 24,40

CORRESPONDANCE | CORRESPONDENCIA | KORRESPONDENZ | CORRESPONDENCE

N°	TYPE TIP TYP	<		>	
		AGRICARB	ORIGINE	AGRICARB	ORIGINE
14	Kongsilde-New Holland	GKO 1201	74966861201	GKO 1201	74966861201
15	Kuhn-Huurd	GKU 0075	52532130	GKU 0075	52532130
16		GKU 0090	52598910 52593410	GKU 0090	52598910 52593410
17		GKU 5120	K2505120	GKU 5120	K2505120
18		GKU 5130	K2505130	GKU 5130	K2505130
19	Kverneland-Maletti	GKU 0090	8007090	GKU 0090	8007090
20		GKV 0105	8009090	GKV 0105	8009090
21	Lely	GLE 0004	116322304	GLE 0004	116322304
22		GLE 102L	1164529440	GLE 102L	1164529440
23	Lemken	GLM 0010	3492001	GLM 0010	3492001
24		GLM 2004	3492004 34910019 34910020	GLM 2004	3492004 34910019 34910020
25		GLM 2005	3492005 34910018	GLM 2005	3492005 34910018
26	Maschio	GMA 0095	27100539	GMA 0095	27100539
27		GMA 0667	26100667	GMA 0667	26100667
28	Perrugini	GSU 0100		GSU 0100	



29 **GAM0055**

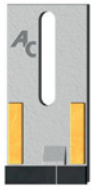

GAM0055

115	55	5	/	Ø 10 mm	
					€
GAM0055					20,70

34 **GSU0100**

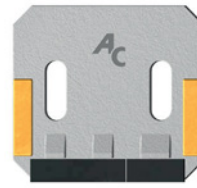

GSU0100

100	90	5	55	Ø 10 mm	
					€
GSU0100					24,40

30 **GRA0080**

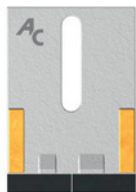

GRA0080

170	80	5	/	Ø 12 mm	
					€
GRA0080					24,40

35 **GSL0090**

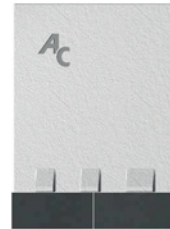

GSL0090

115	90	5	/	/	
					€
GSL0090					22,64

31 **GAM0090**

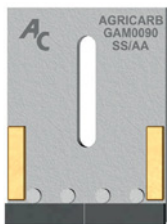

GAM0090

120	90	5	/	Ø 10 mm	
					€
GAM0090					24,40

36 **GSL0100**

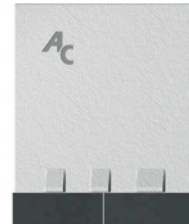

GSL0100

115	100	5	/	/	
					€
GSL0100					23,83

32 **GRA0007**

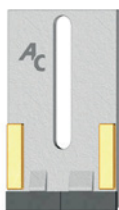

GRA0007

120	70	5	/	Ø 10 mm	
					€
GRA0007					20,70

37 **GVI0005**

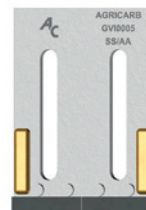

GVI0005

125	90	5	45	Ø 10 mm	
					€
GVI0005					24,40

33 **GAM0090**

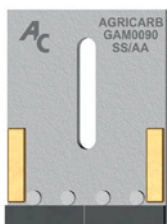









GAM0090

120	90	5	/	Ø 10 mm	
					€
GAM0090					24,40

1 BICA1254 











				
	200	8	43	Ø 10 mm
			€	
BICA1254			72,97	
				

BICA1254

6 BICU0105-HR 











				
	105	4		BTOCC Ø 10 mm
			€	
BICU0105-HR			28,71	
				

BICU0105-HR

2 MDB002140 











				
	140	5		BTOCC Ø 10
			€	
MDB002140			65,80	
				

MDB002140

7 BICU0135-HR 







				
	135	4		BTOCC Ø 10 mm
			€	
BICU0135-HR			32,30	
				

BICU0135-HR

3 MDB002160 









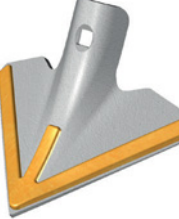

				
	160	5		BTOCC Ø 10
			€	
MDB002160			78,64	
				

MDB002160

8 BICU0150-HR 



				
	150	4		BTOCC Ø 10 mm
			€	
BICU0150-HR			33,50	
				

BICU0150-HR

4 MDRI02150 











				
	150	5		BTOCC Ø 10
			€	
MDRI02150			76,02	
				

MDRI02150

9 BICU0175-HR 











				
	175	4		BTOCC Ø 10 mm
			€	
BICU0175-HR			37,10	
				

BICU0175-HR

5 BICU0080-HR 











				
	80	4	/-	BTOCC Ø 10 mm
			€	
BICU0080-HR			25,12	
				

BICU0080-HR

10 BICU0200-HR 



				
	200	4		BTOCC Ø 10 mm
			€	
BICU0200-HR			40,69	
				

BICU0200-HR

11 MDB001080

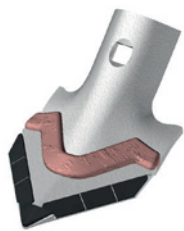

MDB001080

↕	↔	↔	↔	⊕
80	5			BTOCC Ø10
<	>			€
MDB001080				42,14

12 MDB001105



MDB001105

↕	↔	↔	↔	⊕
105	5			BTOCC Ø10
<	>			€
MDB001105				44,28

13 MDB001150

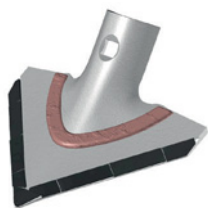

MDB001150

↕	↔	↔	↔	⊕
150	5			BTOCC Ø10
<	>			€
MDB001150				53,82

14 MDB001180



MDB001180

↕	↔	↔	↔	⊕
180	5			BTOCC Ø11
<	>			€
MDB001180				62,01

CORRESPONDANCE | CORRESPONDENCIA | KORRESPONDENZ | CORRESPONDENCE

		<		>		
N°	TYPE TIP TYP	AGRICARB	ORIGINE	AGRICARB	ORIGINE	
1	Carré-Ribouveau-Monosem	BICA 1254		BICA 1254		
2	Einbock	MDB002140		MDB002140		
3		MDB002160		MDB002160		
4	Hatzenbichler	MDRI02150	R409456	MDRI02150	R409456	
5	Universel-Universal	BICU 0080-HR		BICU 0080-HR		
6		BICU 0105-HR		BICU 0105-HR		
7		BICU 0135-HR		BICU 0135-HR		
8		BICU 0150-HR		BICU 0150-HR		
9		BICU 0175-HR		BICU 0175-HR		
10		BICU 0200-HR		BICU 0200-HR		
11		MDBO 01080		MDBO 01080		
12		MDBO 01105		MDBO 01105		
13		MDB001150		MDB001150		
14		MDBO 01180		MDBO 01180		



15 MSBI0080

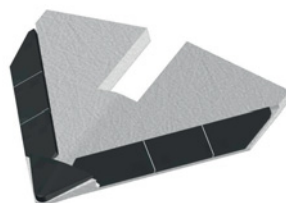

↕	↔	↔	↔	⊗
80	5			
<	>		€	
MSBI0080			29,51	

MSBI0080

16 MSBI0105

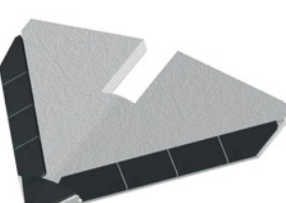

↕	↔	↔	↔	⊗
105	5			
<	>		€	
MSBI0105			31,65	

MSBI0105

17 MSBI0150

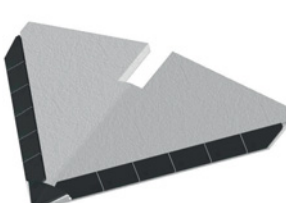

↕	↔	↔	↔	⊗
150	5			
<	>		€	
MSBI0150			41,19	

MSBI0150

18 MSBI0180

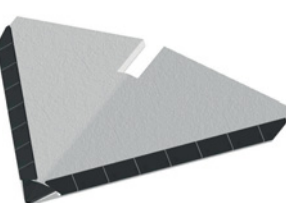

↕	↔	↔	↔	⊗
180	5			
<	>		€	
MSBI0180			49,38	

MSBI0180

19 MSBI0250



↕	↔	↔	↔	⊗
250	8			
<	>		€	
MSBI0250			67,11	

MSBI0250

CORRESPONDANCE | CORRESPONDENCIA | KORRESPONDENZ | CORRESPONDENCE

N°	TYPE TIP TYP	AGRICARB	ORIGINE	AGRICARB	ORIGINE
15	Universel- Universal	MSBI 0080		MSBI 0080	
16		MSBI 0105		MSBI 0105	
17		MSBI 0150		MSBI 0150	
18		MSBI 0180		MSBI 0180	
19		MSBI 0250		MSBI 0250	

Prestation de rechargement
 Welding service / Leistung : Schweissleistungen auf Kreiseleggenzinken /
 Prestación de soldadura

PRIX SUR DEMANDE

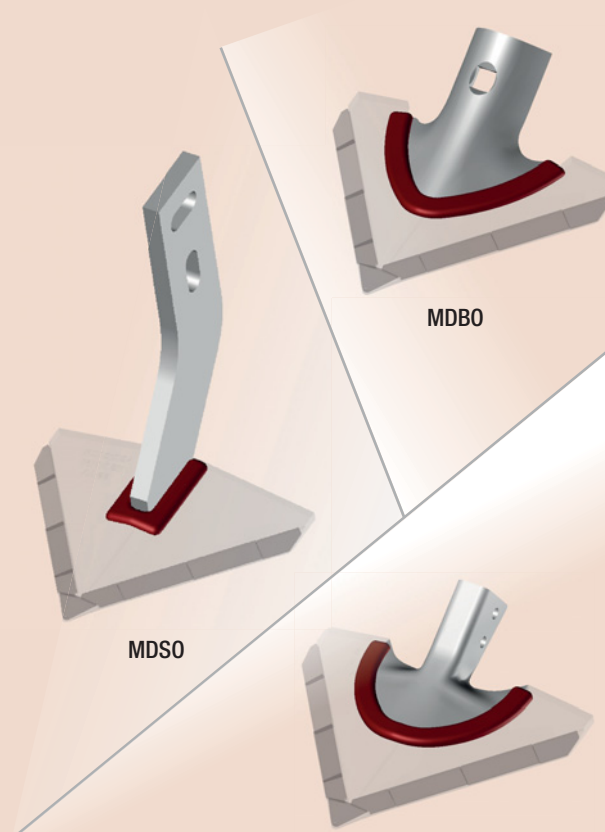

MDSO MDBO MDRI

Jusqu'à 250 mm
 Up to 250 mm | Bis zu 250 mm | Hasta 250 mm

Retrouvez toutes nos prestations page 160 | Find out about all our services on page 160 |
 Informieren Sie sich über alle unsere Dienstleistungen auf Seite 160 | Descubra todos nuestros
 servicios en la página 160.

Notes

Nota | notiz | note



Semis/Récolte Seeding/Crop

Säen/Ernte

Siembra/Cosecha



▲ **Socs arracheuses de betteraves** **124**

Shares for sugarbeet harvesters

Schare für zuckerrübenroder

Rejas arrancadoras de remolacha

▲ **Sabots de semoirs** **126**

Drill parts









Såmaschinenschare

Rejas de sembradora





1 SRH0018 











				
360	60	12	150	BTFCC1240
				
SRH0018G		SRH0018D		150,09

SRH0018G

6 SRM7282 











				
420	170	12	100	BTFCC1240
				
SRM7282G		SRM7282D		199,20

SRM7282G

2 SRH2012 











				
360	60	12	150	BTFCC1240
				
SRH2012G		SRH2012D		154,88

SRH2012G

7 SRR7142 



				
390	215	12	150	BTC2M1245-OB
				
SRR7142G		SRR7142D		150,09

SRR7142G

3 SRH3301 











				
360	60	12	150	BTFCC1240
				
SRH3301G		SRH3301D		150,09

SRH3301G

8 SRR7168 











				
400	140	12	150	BTC2M1245-OB
				
SRR7168G		SRR7168D		176,77

SRR7168G

4 SRM0141 











				
360	160	14	100	BTFCC1240
				
SRM0141G		SRM0141D		184,56

SRM0141G

Varisoc

9 SRV0500 











				
557 (420)	165	12	130	BTFCC1240
				
SRV0500G		SRV0500D		184,56

SRV0500G

5 SRM5060 











				
360	60	18	155	BTFCC1240
				
SRM5060G		SRM5060D		184,56

SRM5060G

Limasoc

10 SRV0501 



				
557 (430)	165	12	130	BTFCC1240
				
SRV0501G		SRV0501D		184,56

SRV0501G

CORRESPONDANCE CORRESPONDENCIA KORRESPONDENZ CORRESPONDENCE					
		<		>	
N°	TYPE TIP TYP	AGRICARB	ORIGINE	AGRICARB	ORIGINE
1		SRH 0018G	016719	SRH 0018D	016718
2	Holmer	SRH 2012G	1145010021	SRH 2012D	1145010020
3		SRH 3301G	023301	SRH 3301D	023300
4		SRM 0141G	17142	SRM 0141D	17141
5	Matrot	SRM 5060G	65061	SRM 5060D	65060
6		SRM 7282G	17283 17278	SRM 7282D	17282 17277
7		SRR 7142G	207143 207139	SRR 7142D	207142 207138
8	Ropa	SRR 7168G	207169	SRR 7168D	207168
9		SRV 0500G	R0500G	SRV 0500D	R0500D
10	Vervaet	SRV 0501G	R0501G	SRV 0501D	R0501D

Notes
Nota | notiz | note



1 SMA0702



452	50	24	65	Ø 12 mm	
				€	
SMA0702				56,41	

SMA0702 Cayena

6 SMH0645



215	150	25	/	Ø 10 mm	
				€	
SMH0645				113,36	

SMH0645

2 SMA2808



221	50	35	/	BTRCC1240-OB	
				€	
SMA2808				63,47	

SMA2808 Primera DMC

7 SMH0656



215	175	25	/	Ø 10 mm	
				€	
SMH0656				113,36	

SMH0656

3 SMA4581



200	50	25	/	Ø 12 mm	
				€	
SMA4581				67,83	

SMA4581

8 SMH0883



215	175	25	/	Ø 10 mm	
				€	
SMH0883				113,36	

SMH0883

4 SMA5961



445	100 (50)	12	/	Ø 16 mm	
				€	
SMA5961				49,01	

SMA5961 Condor

9 SMH0897



215	200	25	/	Ø 10 mm	
				€	
SMH0897				113,36	

SMH0897

5 SMH0262



200	20	70	/	Ø 10 mm	
				€	
SMH0262				68,33	

SMH0262

10 SMK1740



170	48	15	40	BTFC1250	
				€	
SMK1740				32,73	

SMK1740 Vibro Seeder

11 SMK1745



SMK1745

↕	↔	↔	↔	⊞
190	48	15	45	BTFCC1250
				€
SMK1745				32,73

Allrounder, Allseeder

12 SMK3634



SMK3634-F

↕	↔	↔	↔	⊞
178	154	18		
				€
SMK3634				64,95
SMK3634-F				79,95

Maxima

13 SMK4266



SMK4266

↕	↔	↔	↔	⊞
100	50	12	/	BTRCC1240-OB
				€
SMK4266				67,83

14 SMKU0739



SMKU0739

↕	↔	↔	↔	⊞
410	155	50	/	/
				€
SMKU0739				193,39

Planter II

15 SMKU0740



SMKU0740

↕	↔	↔	↔	⊞
450	160	50	/	/
				€
SMKU0740				193,39

Planter II







CORRESPONDANCE | CORRESPONDENCIA | KORRESPONDENZ | CORRESPONDENCE

		<		>	
N°	TYPE I TIP I TYP	AGRICARB	ORIGINE	AGRICARB	ORIGINE
1	Amazone	SMA 0702	970702	SMA 0702	970702
2		SMA 2808	102805 102808	SMA 2808	102805 102808
3		SMA 4581	954581 954581	SMA 4581	954581 954581
4		SMA 5961	225961 207070 218258 218262	SMA 5961	225961 207070 218258 218262
5	Horsch	SMH 0262	00310262 00310987	SMH 0262	00310262 00310987
6		SMH 0645	00310645	SMH 0645	00310645
7		SMH 0656	00310656	SMH 0656	00310656
8		SMH 0883	00310883	SMH 0883	00310883
9	Kongsilde- New Holland	SMH 0897	00310897	SMH 0897	00310897
10		SMK 1740		SMK 1740	
11		SMK 1745		SMK 1745	
1	Kuhn-Huad	SMA 0702	R6014522	SMA 0702	R6014522
12		SMK 3634-F	N1500891 K3634000	SMK 3634-F	K3634000 N1500891
13		SMK 4266	494266	SMK 4266	494266
14		SMKU 0739	VNB0739A	SMKU 0739	VNB0739A
15		SMKU 0740	VNB0740A	SMKU 0740	VNB0740A



16 **SMKU0740** 







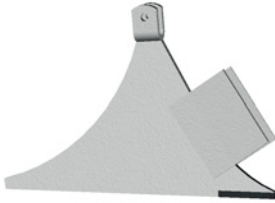

				
450	160	50	/	/
				
			€	
			SMKU0740	
			193,39	

SMKU0740 Planter II

21 **SMM4969** 









				
215		5		
				
			€	
			SMM4969	
			66,02	

SMM4969 MECA V4

17 **SMKU0741** 









				
400	160	50	/	/
				
			€	
			SMKU0741	
			197,19	

SMKU0741 Planter II

22 **SMM5061** 









				
149	85	27	/	/
				
			€	
			SMM5061	
			67,83	

SMM5061

18 **SMKV0092** 









				
315	150	30	/	/
				
			€	
			SMKV0092	
			181,34	

SMKV0092 Monopill

23 **SMM7095** 









				
190	83	28	87	/
				
			€	
			SMM7095	
			107,19	

SMM7095

19 **SMKV3061** 









				
315	150	30	/	/
				
			€	
			SMKV3061	
			187,15	

SMKV3061 Monopill

24 **SMM7896** 







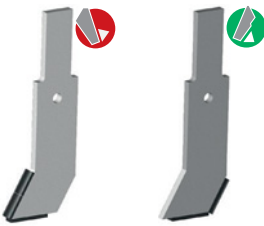

				
142	163	17		05
				
			€	
			SMM7896	
			67,84	

SMM7896

20 **SMM0369** 









				
220	78,5	8	/	BTEX Ø 10 mm
				
			€	
		SMM0369F		SMM0369
		44,99		

SMM0369 SMM0369F

25 **SMM7896-F** 



				
142	163	17		05
				
			€	
			SMM7896-F	
			97,92	

SMM7896-F

26 **SMR3660**



SMR3660

↑↓	↔	↔	↔	⊕
275	25	14	/	Ø 5 mm
				€
SMR3660				22,61

27 **SMR6716**



SMR6716

↑↓	↔	↔	↔	⊕
170	67	17	/	Ø 5 mm
				€
SMR6716				81,52

28 **SMR6718**



SMR6718

↑↓	↔	↔	↔	⊕
130	78	17	/	Ø 5 mm
				€
SMR6718				54,77

29 **SMR7144**



SMR7144

↑↓	↔	↔	↔	⊕
137	86	17	/	Ø 5 mm
				€
SMR7144				67,83

30 **SMR9157**



SMR9157

↑↓	↔	↔	↔	⊕
130	78	17	/	Ø 5 mm
				€
SMR9157				92,31

CORRESPONDANCE CORRESPONDENCIA KORRESPONDENZ CORRESPONDENCE					
		<		>	
N°	TYPE TIP TYP	AGRICARB	ORIGINE	AGRICARB	ORIGINE
16	Kuhn-Huad	SMKU 0740	VNB0740A	SMKU 0740	VNB0740A
17		SMKU 0741	VNB0741A	SMKU 0741	VNB0741A
18	Kverneland	SMKV 0092	AC850092	SMKV 0092	AC850092
19		SMKV 3061	AC853061	SMKV 3061	AC853061
20	Monosem	SMM 0369F	30020369	SMM 0369	30020369
21		SMM4969	66004969 65104969	SMM4969	66004969 65104969
22		SMM 5061	5061	SMM 5061	5061
23		SMM 7095	30047095 62761 6276-1 6276.1	SMM 7095	30047095 62761 6276-1 6276.1
24		SMM 7896	30048020 65107897 30048009 65009510	SMM 7896	30048020 65107897 30048009 65009510
25		SMM 7896-F	65107896 65107898 66006363 65103924	SMM 7896-F	65107896 65107898 66006363 65103924
26		SMR 3660	41073660 41077101	SMR 3660	41073660 41077101
27		SMR 6716	6716	SMR 6716	6716
28		SMR 6718	6718	SMR 6718	6718
29		SMR 7144	7144	SMR 7144	7144
30	SMR 9157	9157	SMR 9157	9157	

31 SMN0015



100	50	12	/	/
				€
SMN0015				67,83

SMN0015

36 SFS6002 Yetter, AG Systèmes



360	120	8	45-75	Ø 12 mm
				€
SFS6002				137,60

SFS6002

32 SMH0262



200	20	70	/	Ø 10 mm
				€
SMH0262				68,33

SMH0262

37 SMU0045



170	40	12	45	BTFCC1060-NY
				€
SMU0045				32,73

SMU0045

Gaspardo Scatenata, Aguirre RS 7000, Lamusa, Sola Neomassen, Kverneland Kubota, Accord TS EVO, Kühn Megant & Razol Téos

33 SMS2803



169	50	15	/	/
				€
SMS2803				39,83

SMS2803

38 SVI2039 Cintré | Cimbrado | Gewölbt | Curved



200	40	12	45	BTFCC Ø 10 mm
				€
SVI2039				31,28

SVI2039

Gaspardo Scatenata, Aguirre RS 7000, Lamusa, Sola Neomassen, Kverneland Kubota, Accord TS EVO, Kühn Megant & Razol Téos

34 SMS9780



270	50	18	/	/
				€
SMS9780				90,70

SMS9780

Tramline, Xeos

39 SMV0058



406	41	12	/	/
				€
SMV0058				46,16

SMV0058

Seed Hawk

35 SFS5936 Yetter, AG Systèmes



440	92	20	45-70	Ø 12 mm
				€
SFS5936				82,57

SFS5936

40 SMV0695



535	51	12	153	/
				€
SMV0695				85,80

SMV0695

Seed Hawk

41 BDV9998



BDV9998



150	45	10	/	Ø 12 mm
				€
BDV9998				22,74

Rapid

CORRESPONDANCE CORRESPONDENCIA KORRESPONDENZ CORRESPONDENCE					
		<		>	
N°	TYPE I TIP I TYP	AGRICARB	ORIGINE	AGRICARB	ORIGINE
31	Nodet	SMN 0015	BPX00015	SMN 0015	BPX00015
32	Simba	SMH 0262		SMH 0262	
33	Sola	SMS 2803	052803	SMS 2803	052803
	Sulky	SMS 2803	052803	SMS 2803	052803
34				SMS 9780	909780
35		SFS 5936		SFS 5936	
36		SFS 6002		SFS 6002	
37	Universel- Universal	SMU 0045		SMU 0045	
		SVI 2039		SVI 2039	
39	Vaderstad	SMV 0058	310058	SMV 0058	310058
		SMV 0695	310695	SMV 0695	310695
		BDV 9998	41998-1	BDV 9998	41998-1

Notes
Nota | notiz | note

Vigne Vineyard Equipment

Weinbau

Viña



▲ **Socs vigne et cote de melon** 134

Shares for vineyard cultivation

Schare für weinbau

Rejas de viña y catalana

▲ **Ailerons** 136

Wings

Flügelschare

Alas

▲ **Socs triangulaires** 138

Duckfoot points

Gänsefußschare

Rejas de golondrinas

▲ **Decompacteurs et sabots** 140

Deep tillage and Subsoiling Shares

Tiefenlockerung

Decompactadores y Botas

▲ **Autres socs, Pointes mobiles et rasettes** 142

Other shares, Weld-on points & Skim points

Andere schare, Meißelspitzen & Vorschälerschare

Otras rejas, Formones de arado & Rasetas

▲ **Interceps** 144

Interceps

Anschweiß

Intercepas

▲ **Type Actisol, Agrisem, Kongskilde, Cultibio** 146

To fit Actisol, Agrisem, Kongskilde & Cultibio

Passend für Actisol, Agrisem, Kongskilde & Cultibio

Tipo Actisol, Agrisem, Kongskilde, Cultibio



1 **VGB03300**

245	80	12	35	BTFCC Ø 10 mm
				€
VGB03300				54,52



VGB03300

6 **SCK3032**

360	60	20	70	BTC2M1690-NY BTC2M16115-NY
				€
SCK3032				62,46



SCK3032

Cultivateur lourd-Non-stop

2 **SOC6836F**

360	68	25	35-75	BTFCC1260
				€
SOC6836FG		SOC6836FD		139,01



SOC6836FG

7 **SOC0050**

360	50	20	40-85	BTFCC1260
				€
SOC0050				52,59



SOC0050

3 **SOC6836**

375	68	25	35-75	BTFCC Ø 12 mm
				€
SOC6836				64,38



SOC6836

8 **SOC0060**

360	60	20	45-85	BTFCC1260
				€
SOC0060				53,63



SOC0060

4 **SOC203V** Type Double Cœur | Tipo corazón doble
| Typ Doppelherz | Type Double-Heart

420	100	20	45-80	BTFCC1280
				€
SOC203V				114,62



SOC203V

9 **SOC0060-RV**

355	60	32,5	45-85	BTFCC1260
				€
SOC0060-RV				86,82



SOC0060-RV

5 **SOC213V**

420	100	20	45-80	BTFCC1480
				€
SOC213V				114,62



SOC213V

Mixer

10 **SOC0060-XT**

355	60	27	45-85	BTFCC1260
				€
SOC0060-XT				77,12



SOC0060-XT

11 SOC060A



SOC060A

Q

↕	↔	↔	↔	⊕
360	60	20	45-85	BTFC1260
< >				€
SOC060A				113,08

12 SOC060F



SOC060FG

Q

↕	↔	↔	↔	⊕
360	60	20	45-85	BTFC1260
< >				€
SOC060FG		SOC060FD		135,88

13 SOC4050



SOC4050

Q

↕	↔	↔	↔	⊕
310	40	20	40-60	BTFC1260
< >				€
SOC4050				43,85

CORRESPONDANCE | CORRESPONDENCIA | KORRESPONDENZ | CORRESPONDENCE

		<	>
N°	TYPE TIP TYP	AGRICARB	ORIGINE
1	Boisselet	VGB0 3300	0033001
2	Catalana	SOC 6836FG	SOC 6836FD
3		SOC 6836	SOC 6836
4	Farmet	SOC 203V	SOC 203V
5	Goizin	SOC 213V	SOC 213V
6	Kirpy	SCK 3032	2093032
7	Universel- Universal	SOC 0050	SOC 0050
8		SOC 0060	SOC 0060
9		SOC 0060-RV	SOC 0060-RV
10		SOC 0060-XT	SOC 0060-XT
11		SOC 060A	SOC 060A
12		SOC 060FG	SOC 060FD
13		SOC 4050	SOC 4050
3		SOC 6836	SOC 6836

COTE DE MELON CATALANA

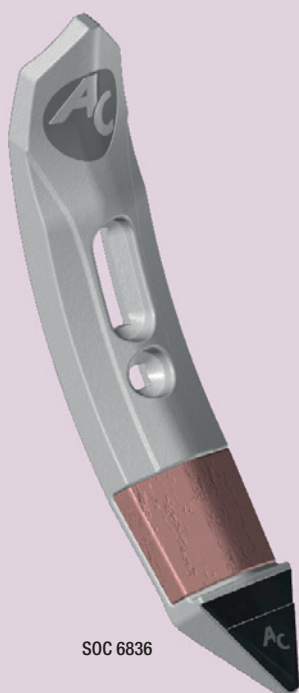

SOC 6836

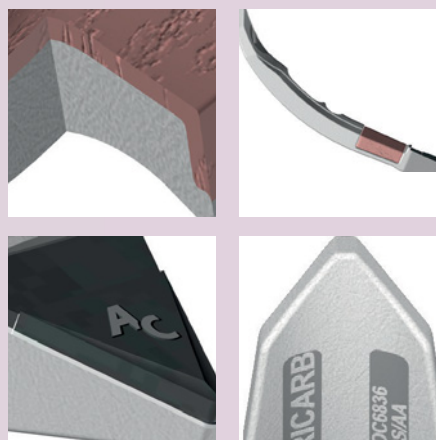

1 VAFE6600

370	12	43-70	Ø12	
		VAFE6600		€
				155,04



VAFE6600

6 VAGA0007

400	12	44-56	Ø 12 mm	
		VAGA0007		€
				117,82



VAGA0007

2 VAGA4600

390	10	65-85	Ø12	
		VAGA4600		€
				151,93



VAGA4600

BIO2000, HERBIVIGNE, HERBIVORE

7 VAGA0400

285	400	12		
		VAGA0400		€
				190,60



VAGA0400

Cultivigne

3 VAGA5400

390	10			
		VAGA5400		€
				151,93

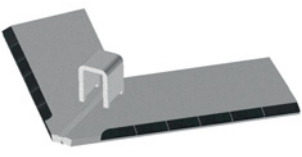

VAGA5400

BIO2000, HERBIVIGNE, HERBIVORE

8 ADQ4012

400	12	45-85	BTFCC1280	
		ADQ4012		€
				223,64



ADQ4012

4 VAGA5700

390	10			
		VAGA5700		€
				151,93

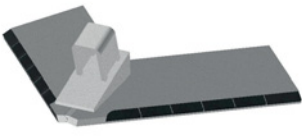

VAGA5700

BIO2000, HERBIVIGNE, HERBIVORE

9 ADQ5012

500	12	45-85	BTFCC1290	
		ADQ5012		€
				240,20



ADQ5012

5 VAGA0006

312	12	44-56	Ø 12 mm	
		VAGA0006		€
				105,66



VAGA0006

10 ADQ5014

500	12	45-85	BTFCC1490	
		ADQ5014		€
				240,20

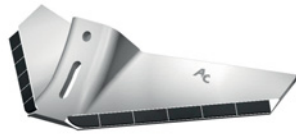

ADQ5014

11 ADU3214



ADU3214

Q				
↕	↔	↔	↔	⊕
300	12	45-75	BTFC1290	
<	>	€		
ADU3214			131,83	
⊕				

12 ADU3214C



ADU3214CG

Q				
↕	↔	↔	↔	⊕
260	14	45-75	BTFC1290	
<	>	€		
ADU3214CG	ADU3214CD	84,83		
⊕				









CORRESPONDANCE CORRESPONDENCIA KORRESPONDENZ CORRESPONDENCE					
		<		>	
N°	TYPE TIP TYP	AGRICARB	ORIGINE	AGRICARB	ORIGINE
1	Ferrand	VAFE 6600		VAFE 6600	
2	Gard	VAGA 4600	408834600	VAGA 4600	408834600
3		VAGA 5400		VAGA 5400	
4		VAGA 5700		VAGA 5700	
5	Gardell	VAGA 0006	006	VAGA 0006	006
6		VAGA 0007	007	VAGA 0007	007
7		VAGA 0400	G-400	VAGA 0400	G-400
8	Universel- Universal	ADQ 4012		ADQ 4012	
9		ADQ 5012	GX460NS	ADQ 5012	GX460NS
10		ADQ 5014	7002	ADQ 5014	7002
11		ADU 3214	13100043	ADU 3214	13100043
12		ADU 3214CG		ADU 3214CD	

Notes
Nota | notiz | note





1 STB0173M 











				
280	18	45	BTFCC1250	
				
STB0173M		117,45		
				

STB0173M Swifter

6 STF0236M 











				
265	17	/	BTFCC1250	
				
STF0236M		117,45		
				

STF0236M Kompaktomat

2 VSTB3011 











				
120	12	35	BTFCC Ø10	
				
VSTB3011		121,96		
				

VSTB3011

7 STU1810M 











				
185	20	45	BTFCC Ø10	
				
STU1810M		80,65		
				

STU1810M

3 VSTB3013 











				
200	12	35	BTFCC Ø10	
				
VSTB3013		137,52		
				

VSTB3013

8 STU2512M 











				
250	20	40-65	BTFCC Ø 12 mm	
				
STU2512M		102,70		
				

STU2512M

4 VSTB3014 











				
250	12	35	BTFCC Ø10	
				
VSTB3014		153,68		
				

VSTB3014

9 STU3012M 











				
300	20	40-65	BTFCC Ø 12 mm	
				
STU3012M		111,32		
				

STU3012M

5 VSTB3053 











				
200	12	45	BTFCC Ø10	
				
VSTB3053		137,52		
				

VSTB3053

10 STU3812M 



				
380	20	40-65	BTFCC Ø 12 mm	
				
STU3812M		128,66		
				

STU3812M

Prestation de soudage

Welding service / Umbau von Gänsefußschare / Prestación de soldadura

/ **PSS T** 🔍

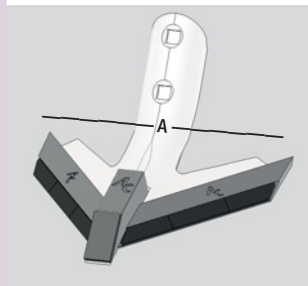

↔	
PSST 1020 : 100 mm ≤ A 200 mm	
PSST 2030 : 200 mm ≤ A 300 mm	
PSST 3040 : 300 mm ≤ A 400 mm	
⏪	⏩
	€
PSST-1020	72,31
PSST-2030	86,02
PSST-3040	98,78
⚙️	

Retrouvez toutes nos prestations page 160 | Find out about all our services on page 160 | Informieren Sie sich über alle unsere Dienstleistungen auf Seite 160 | Descubra todos nuestros servicios en la página 160.

CORRESPONDANCE CORRESPONDENCIA KORRESPONDENZ CORRESPONDENCE					
		⏪		⏩	
N°	TYPE TIP TYP	AGRICARB	ORIGINE	AGRICARB	ORIGINE
1	Bednar	STB 0173M	KM060173	STB 0173M	KM060173
2	Boisselet	VSTB 3011	33011 KM0033011	VSTB 3011	33011 KM0033011
3		VSTB 3013	33013 KM0033013	VSTB 3013	33013 KM0033013
4		VSTB 3014	33014 KM0033014	VSTB 3014	33014 KM0033014
5		VSTB 3053	33053 KM0033053	VSTB 3053	33053 KM0033053
6		Farmet	STF 0236M	3000236	STF 0236M
7	Universel- Universal	STU 1810M		STU 1810M	
8		STU 2512M		STU 2512M	
9		STU 3012M		STU 3012M	
10		STU 3812M		STU 3812M	

Nota | notiz | note
Notes



1 SDAG7032-R 🔍 Encastrement : 32

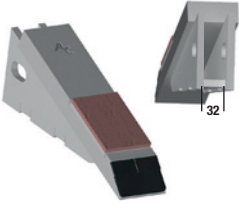

↕	↔	↗↘	↻	⬡
335	70	30	/	Ø 19 mm
◀	▶	€		
SDAG7032-R				119,35
🌀				

SDAG7032-R SJ

6 SDG01003 🔍 Encastrement : 21

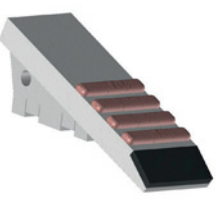

↕	↔	↗↘	↻	⬡
200	60	20		
◀	▶	€		
SDG01003				102,86
🌀				

SDG01003

2 SDAG7042-R 🔍 Encastrement : 42

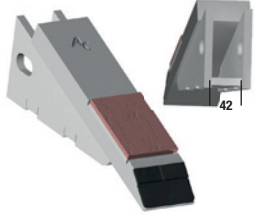

↕	↔	↗↘	↻	⬡
345	70	30	/	Ø 19 mm
◀	▶	€		
SDAG7042-R				119,35
🌀				

SDAG7042-R SJ

7 VBKI8342 🔍



↕	↔	↗↘	↻	⬡
420	80	30	60	16TF1E
◀	▶	€		
VBKI8342				204,45
🌀				

VBKI8342

3 BLR0085 🔍



↕	↔	↗↘	↻	⬡
410	50	40	85	/
◀	▶	€		
BLR0085G	BLR0085D	251,17		
🌀				

BLR0085G ARAPLOW, ACB

8 SCK0792 🔍



↕	↔	↗↘	↻	⬡
283	110	22	45	BTFC1260
◀	▶	€		
SCK0792				59,92
🌀				

SCK0792 Vibroflex

4 CLR0085 🔍



↕	↔	↗↘	↻	⬡
350	210	20	85	BTFC1440 Goupilles
◀	▶	€		
CLR0085G	CLR0085D	206,27		
🌀				

CLR0085G

9 SCK0800 🔍



↕	↔	↗↘	↻	⬡
283	65	22	45	BTFC1260
◀	▶	€		
SCK0800				53,18
🌀				

SCK0800 Vibroflex

5 SDGA0040-R 🔍 Encastrement : 43

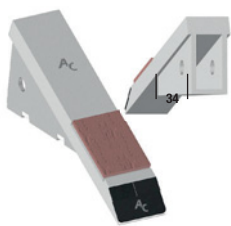

↕	↔	↗↘	↻	⬡
350	70	30		
◀	▶	€		
SDGA0040-R				147,45
🌀				

SDGA0040-R

10 BDS7050 🔍



↕	↔	↗↘	↻	⬡
160	70	25	50	BTFC1250
◀	▶	€		
BDS7050				60,91
BDS7050-R				84,33
🌀				

BDS7050 Hélios

11 SDJ1020-R



SDJ1020-R

330	70	116	/	/
				€
SDJ1020-R				148,54

CORRESPONDANCE CORRESPONDENCIA KORRESPONDENZ CORRESPONDENCE					
		<		>	
N°	TYPE TIP TYP	AGRICARB	ORIGINE	AGRICARB	ORIGINE
1	Agric-Jympa	SDAG 7032-R		SDAG 7032-R	
2		SDAG 7042-R		SDAG 7042-R	
3	Gard	BLR 0085G		BLR 0085D	
4		CLR 0085G		CLR 0085D	
5	Gardell	SDGA 0040-R	Dent 40	SDGA 0040-R	Dent 40
6	Goizin	SDGO 1003	701005	SDGO 1003	701005
8	Grégoire-Besson	SCK 0792	105000792 105000794	SCK 0792	105000792 105000794
7	Kirpy, Grenier	VBKI 8342		VBKI 8342	
8	Kongskilde-New Holland	SCK 0792	105000792 105000794	SCK 0792	105000792 105000794
9		SCK 0800	105000800	SCK 0800	105000800
10	Lame Michel	BDS 7050		BDS 7050-R	
11	Jean-de-Bru	SDJ 1020-R		SDJ 1020-R	
3	Razol	BLR 0085G		BLR 0085D	
4		CLR 0085G		CLR 0085D	
10	Universel-Universal	BDS 7050		BDS 7050-R	
11		SDJ 1020-R		SDJ 1020-R	



1 VRB03021



VRB03021G

↕	↔	↔	↔	⊕
200	70	12	35	BTFC010
◀		▶		€
VRB03021G		VRB03021D		165,56
⊕				

2 VRB03025



VRB03025G

↕	↔	↔	↔	⊕
300	70	12	35	BTFC010
◀		▶		€
VRB03025G		VRB03025D		213,74
⊕				

CORRESPONDANCE | CORRESPONDENCIA | KORRESPONDENZ | CORRESPONDENCE

		◀		▶	
N°	TYPE TIP I TYP	AGRICARB	ORIGINE	AGRICARB	ORIGINE
1	Boisselet	VRBO 3021G	33021	VRBO 3021D	33022

CORRESPONDANCE | CORRESPONDENCIA | KORRESPONDENZ | CORRESPONDENCE

		◀		▶	
N°	TYPE TIP I TYP	AGRICARB	ORIGINE	AGRICARB	ORIGINE
2	Boisselet	VRBO 3025G	33025	VRBO 3025D	33026

▲ SOCS A BOULONNER | BOLT-ON SHARES
ANSCHRAUBSCHARE | REJAS DE ARADO

1 VSGA5500

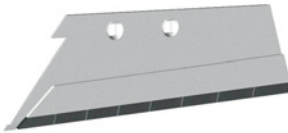

VSGA5500G

↕	↔	↔	↔	⊕
365	117	12	70	BTFC012
◀		▶		€
VSGA5500G		VSGA5500D		182,34
⊕				

2 VSGA5900

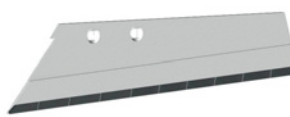

VSGA5900G

↕	↔	↔	↔	⊕
480	115	12	70	BTFC012
◀		▶		€
VSGA5900G		VSGA5900D		182,34
⊕				

CORRESPONDANCE | CORRESPONDENCIA | KORRESPONDENZ | CORRESPONDENCE

		◀		▶	
N°	TYPE TIP I TYP	AGRICARB	ORIGINE	AGRICARB	ORIGINE
1	Gard	VSGA 5500G	30325600	VSGA 5500D	30325500

CORRESPONDANCE | CORRESPONDENCIA | KORRESPONDENZ | CORRESPONDENCE

		◀		▶	
N°	TYPE TIP I TYP	AGRICARB	ORIGINE	AGRICARB	ORIGINE
2	Gard	VSGA 5900G	30325900	VSGA 5900D	30326000

1 CMG0305 🔍 Contre lame



↕	↔	↗	↻	⬡
493	30	25	25	/
◀	▶	€		
CMG0305		99,51		

CMG0305

3 PMG0030 🔍



↕	↔	↗	↻	⬡
570	30	30	/	/
◀	▶	€		
PMG0030		118,28		

PMG0030

2 CMG3306 🔍 Contre lame



↕	↔	↗	↻	⬡
470	30	25	25	Ø 12 mm
◀	▶	€		
CMG3306		99,51		

CMG3306

4 PMV5325 🔍



↕	↔	↗	↻	⬡
530	25	25	/	/
◀	▶	€		
PMV5325		73,38		

PMV5325

CORRESPONDANCE | CORRESPONDENCIA | KORRESPONDENZ | CORRESPONDENCE

		◀			▶
N°	TYPE TIP TYP	AGRICARB	ORIGINE	AGRICARB	ORIGINE
1	Gard	CMG 0305	30330305	CMG 0305	30330305
2		CMG 3306	30330306	CMG 3306	30330306

CORRESPONDANCE | CORRESPONDENCIA | KORRESPONDENZ | CORRESPONDENCE

		◀			▶
N°	TYPE TIP TYP	AGRICARB	ORIGINE	AGRICARB	ORIGINE
3	Gregoire-Besson	PMG 0030	171207 172208	PMG 0030	171207 172208
4	Universel- Universal	PMV 5325		PMV 5325	

SOCS DÉCAVAILLONNEUSE | CUTTER SHARE ▲
MESSERSCHAR | PALA DEL INTERCEPAS

1 VSB03125 🔍



↕	↔	↗	↻	⬡
240	180	12	105	BTFC0 Ø10
◀	▶	€		
VSB03125G	VSB03125D	197,68		

VSB03125G

2 VSB03127 🔍



↕	↔	↗	↻	⬡
300	180	12	105	BTFC0 Ø10
◀	▶	€		
VSB03127G	VSB03127D	234,69		

VSB03127G

CORRESPONDANCE | CORRESPONDENCIA | KORRESPONDENZ | CORRESPONDENCE

		◀			▶
N°	TYPE TIP TYP	AGRICARB	ORIGINE	AGRICARB	ORIGINE
1	Boisselet	VSB0 3125G	33125	VSB0 3125D	33126

CORRESPONDANCE | CORRESPONDENCIA | KORRESPONDENZ | CORRESPONDENCE

		◀			▶
N°	TYPE TIP TYP	AGRICARB	ORIGINE	AGRICARB	ORIGINE
2	Boisselet	VSB0 3127G	33127	VSB0 3127D	33128



1 VIAC8202



65	400	6		
				€
VIAC8202G	VIAC8202D			127,71

VIAC8202G

6 VIB09592



350	75	8		
				€
VIB09592G	VIB09592D			144,66

VIB09592G

2 VIAC9175



	450	10		
				€
VIAC9175G	VIAC9175D			461,12

VIAC9175G

7 VIB09593

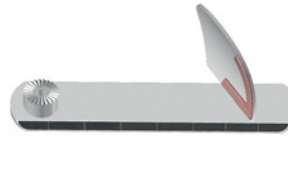

400	75	8		
				€
VIB09593G	VIB09593D			176,50

VIB09593G

3 VIAC9271



	550	10		
				€
VIAC9271G	VIAC9271D			480,65

VIAC9271G

8 VIB09594



400	75	8	/	/
				€
VIB09594G	VIB09594D			158,82

VIB09594G

4 VDB03747



250	250	8		
				€
VDB03747G	VDB03747D			155,24

VDB03747G

9 VIBR1131



500	90	10		
				€
VIBR1131G	VIBR1131D			309,98

VIBR1131G

5 VDB03748



350	350	8		
				€
VDB03748G	VDB03748D			215,30

VDB03748G

10 VIBR2151



350	95	10	/	/
				€
VIBR2151G	VIBR2151D			251,36

VIBR2151G

Intercep LUV

11 VICL0257

570	145	6	/	/
VICL0257G	VICL0257D			302,42
Radius				

VICL0257G

12 VICL5316

370	140	6		
VICL5316G	VICL5316D			249,68

VICL5316G

13 VIFE1100

430	120	8		
VIFE1100G	VIFE1100D			140,66

VIFE1100G

14 VIFE8600

530	120	8		
VIFE8600G	VIFE8600D			171,93

VIFE8600G

15 VISPO400

NEW

400				
VISPO400G	VISPO400D			171,93

VISPO400G

CORRESPONDANCE | CORRESPONDENCIA | KORRESPONDENZ | CORRESPONDENCE

N°	TYPE TIP TYP	AGRICARB	ORIGINE	AGRICARB	ORIGINE	
1		VAC 8202G	19182004	VAC 8202D	19182002	
2	Actisol	VAC 9175G	19100076 V47 g	VAC 9175D	19100075 V47 d	
3		VAC 9271G	19200072 V60 g	VAC 9271D	19200071 V60 d	
4		VDBO 3747G	333747	VDBO 3747D	333747	
5		VDBO 3748G	333748	VDBO 3748D	333748	
6	Boisselet	VIBO 9592G	9591	VIBO 9592D	9592	
7		VIBO 9593G	B00009593-1	VIBO 9593D	B00009594-1	
8		VIBO 9594G		VIBO 9594D		
9	Braun	VIBR 1131G	001211311	VIBR 1131D	001211301	
10		VIBR 2151G	00121511	VIBR 2151D	0012151	
11	Clemens	VICL 0257G	90257	VICL 0257D	90257	
12		VICL 5316G	653.001600 G	VICL 5316D	653.001660 D	
13	Ferrand	VIFE 1100G	IN021100X	VIFE 1100D	IN021100X	
14		VIFE 8600G	IN018600X	VIFE 8600D	IN018600X	
15	Spedo	VISP 0400G		VISP 0400D		
16		VISP 0540G		VISP 0540D		

16 VISPO540

NEW









540				
VISPO540G	VISPO540D			171,94

VISPO540G





1 CMA4222 











				
450	22	22	22	BTFHC1440
				€
CMA4222				53,53
				

CMA4222 B1

6 SFA9111 











				
	400	10	55-65	Ø 12 mm
				€
SFA9111				213,11
				

SFA9111 B1

2 CMA4225 











				
420	25	25	25	BTFHC1440
				€
CMA4225	CMA4225			61,25
				

CMA4225 B2, B3, Fissol

7 SFA9113 











				
	500	10	55-65	Ø 12 mm
				€
SFA9113				240,03
				

SFA9113 B1

3 CMA9325 











				
146	60	15	/	/
				€
CMA9325				68,15
				

CMA9325

8 SFA9151 











				
	230	10	55-65	Ø 12 mm
				€
SFA9151G	SFA9151D			129,56
				

SFA9151G B1

4 SFA9102 











				
210	60	10	55-65	Ø 12 mm
				€
SFA9102				54,05
				

SFA9102 B1

9 SFA9206 











				
194	56	6		Ø 14 mm
				€
SFA9206				104,38
				

SFA9206 B2

5 SFA9106 











				
110	55	6	/	/
				€
SFA9106				104,38
				

SFA9106 B1

10 SFA9303 



				
235	60	15	55-65	Ø 12mm
				€
SFA9303				59,74
				

SFA9303 B3

11 SFA9304

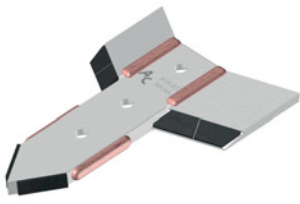

SFA9304

180	15	55-65	Ø 12mm	
SFA9304			€	
128,35				

B3

12 SFA9307

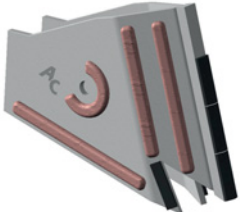

SFA9307

235	60	15	/	/
SFA9307			€	
119,80				

B3

13 SFA9311



SFA9311

400	15	55-65	Ø 12mm	
SFA9311			€	
218,47				

B3

14 SFA9312



SFA9312

460	12	55-65	Ø 12 mm	
SFA9312			€	
230,37				

B3

15 SFA9313



SFA9313

248	60	19	120	BTCAC1330
SFA9313			€	
59,73				

FISSOL

CORRESPONDANCE | CORRESPONDENCIA | KORRESPONDENZ | CORRESPONDENCE

N°	TYPE TIP TYP	<		>	
		AGRICARB	ORIGINE	AGRICARB	ORIGINE
1		CMA 4222	19100004 19100005	CMA 4222	19100004 19100005
2		CMA 4225	19200004 19200005B	CMA 4225	19200004 19200005B
3		CMA 9325	19300025 19300028	CMA 9325	19300025 19300028
4		SFA 9102	19100002 19200003	SFA 9102	19100002 19200003
5		SFA 9106	19100006 19100007	SFA 9106	19100006 19100007
6		SFA 9111	19100011 19100020	SFA 9111	19100011 19100020
7		SFA9113	19100013	SFA9113	19100013
8	Actisol	SFA 9151G	19100051	SFA 9151D	19100050
9		SFA 9206	19200006 19200007	SFA 9206	19200006 19200007
10		SFA 9303	19300003 19300002	SFA 9303	19300003 19300002
11		SFA 9304	19300004 19300039	SFA 9304	19300004 19300039
12		SFA 9307	19300007 19300006 19300017	SFA 9307	19300007 19300006 19300017
13		SFA 9311	19300011	SFA 9311	19300011
14		SFA9312	19300012	SFA9312	19300012
15		SFA9313	19310003 19310002	SFA9313	19310003 19310002



16 SFA9317



SFA9317

126	55	58		
				€
SFA9317				79,81

FISSOL

21 LAG1265



LAG1265G

310	217	12	/	BTFHC1645-NY
				€
LAG1265G		LAG1265D		318,31

17 SFA9318



SFA9318

381	40	55		Goupille 10x40
				€
SFA9318				149,67

FISSOL

22 VSDC2160

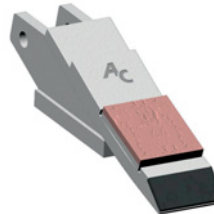

VSDC2160

210	60	80	/	Ø 12 mm
				€
VSDC2160		VSDC2160		115,58

18 SFA9321



SFA9321

168	55	5		
				€
SFA9321				81,91

FISSOL

19 SFA9339



SFA9339

248	182	27		BTCAC1330
				€
SFA9339				128,35

FISSOL

20 LAB5122



LAB5122G

112	90	24	68,5	BTFHC1225
				€
LAB5122G		LAB5122D		67,48

Agromulch, Cultiplow, Actimulch

**Montage Actisol
FISSOL**

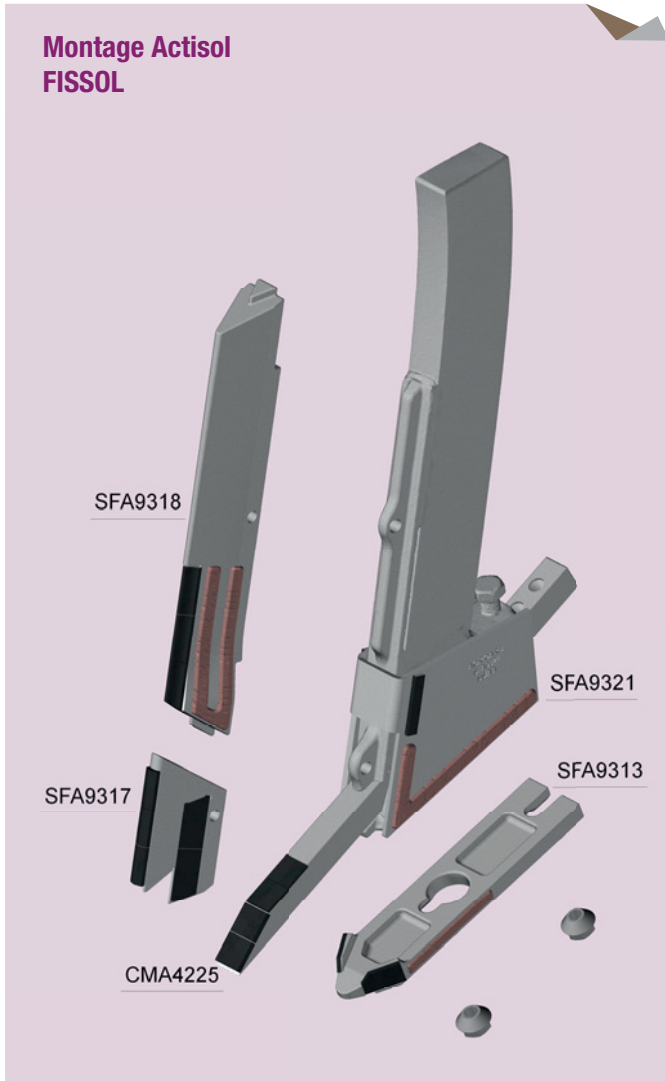

CORRESPONDANCE CORRESPONDENCIA KORRESPONDENZ CORRESPONDENCE					
		<		>	
N°	TYPE TIP TYP	AGRICARB	ORIGINE	AGRICARB	ORIGINE
16		SFA 9317	19310007A 19310006C	SFA 9317	19310007A 19310006C
17		SFA 9318	19310008	SFA 9318	19310008
18		SFA 9321	19310021	SFA 9321	19310021
19	Agrisem	SFA 9339	19310039A 19310004A	SFA 9339	19310039A 19310004A
20		LAB 5122G	BOR15-121 BOR15-122 BOR15-28	LAB 5122D	BOR15-121 BOR15-122 BOR15-28
21		LAG 1265G	1510212	LAG 1265D	1510211
22	Cultibio	VSDC 2160		VSDC 2160	

Notes
Nota | notiz | note



Mises à souder Weld-on parts

Anschweißteile

Piezas diversas para soldar



▲ **Type « Agrisem »** 152

To fit «Agrisem»

Passend für «Agrisem»

Para tipo «Agrisem»

▲ **Becs déchaumage & ailerons double cœur** 154

For cultivation, double-heart wings

Für stoppelbearbeitung, doppelherz-flügelschare

Puntas cultivador & alerones doble corazon

▲ **Pointes mobiles à souder** 156

Weld-on points

Meißelspitzen

Formones de arado para soldar

▲ **Réparation dents de herse** 157

Weld-on strips for power harrow tines

Anschweißteile für kreiseleggen zinken

Reparación dientes de grada rotativa

▲ **Pour contre-seps, talons, coutres & socs** 158

Landside & coulters

Anlagenschoner & anlagenseche

Taloneras, rejas & puntas

▲ **Déchaumage, élevage & matériel spécifique** 159

For cultivation, nitrogen coulters, specific equipment

Für stoppelbearbeitung, gülleschleifschuh, spezielle geräte

Cultivador, materiales específicos

▲ **Prestation de rechargement** 160

Welding service

Schweisleistungen

Prestacion de soldadura





		AC		L x H x E L x H x T L x H x D L x A x E	À souder sur To weld on Anzuschweißen auf Para soldar sobre	€
N°	GENRE TO FIT PASSEND FÜR TIPO	<	>			
1	AGRISEM	BEC7330		300x70x30	Becs à souder sur Ailettes genre Cultiplow, Terraplow Wings to weld on machines type Cultiplow or Terraplow Flügelschare anzuschweißen auf maschinen typ Cultiplow oder Terraplow Puntas para soldar sobre laminas tipo Cultiplow, Terraplow	77,51
		BEC7330-R		300x70x30		99,38
2		BOA0135G	BOA0135D	135x40x12		44,63
3		BOA1264G	BOA1264D	180x70x14		61,42
4		BOA1267G	BOA1267D	320x70x14		98,30
5		BOA1268G	BOA1268D	360x70x14		107,06
6		RPA5024		235x54x20	65,01	

Réparation d'une lame AGRISEM

Repair of an AGRISEM blade / Instandsetzung von einem AGRISEM Messer /
Reparación de una lámina tipo AGRISEM

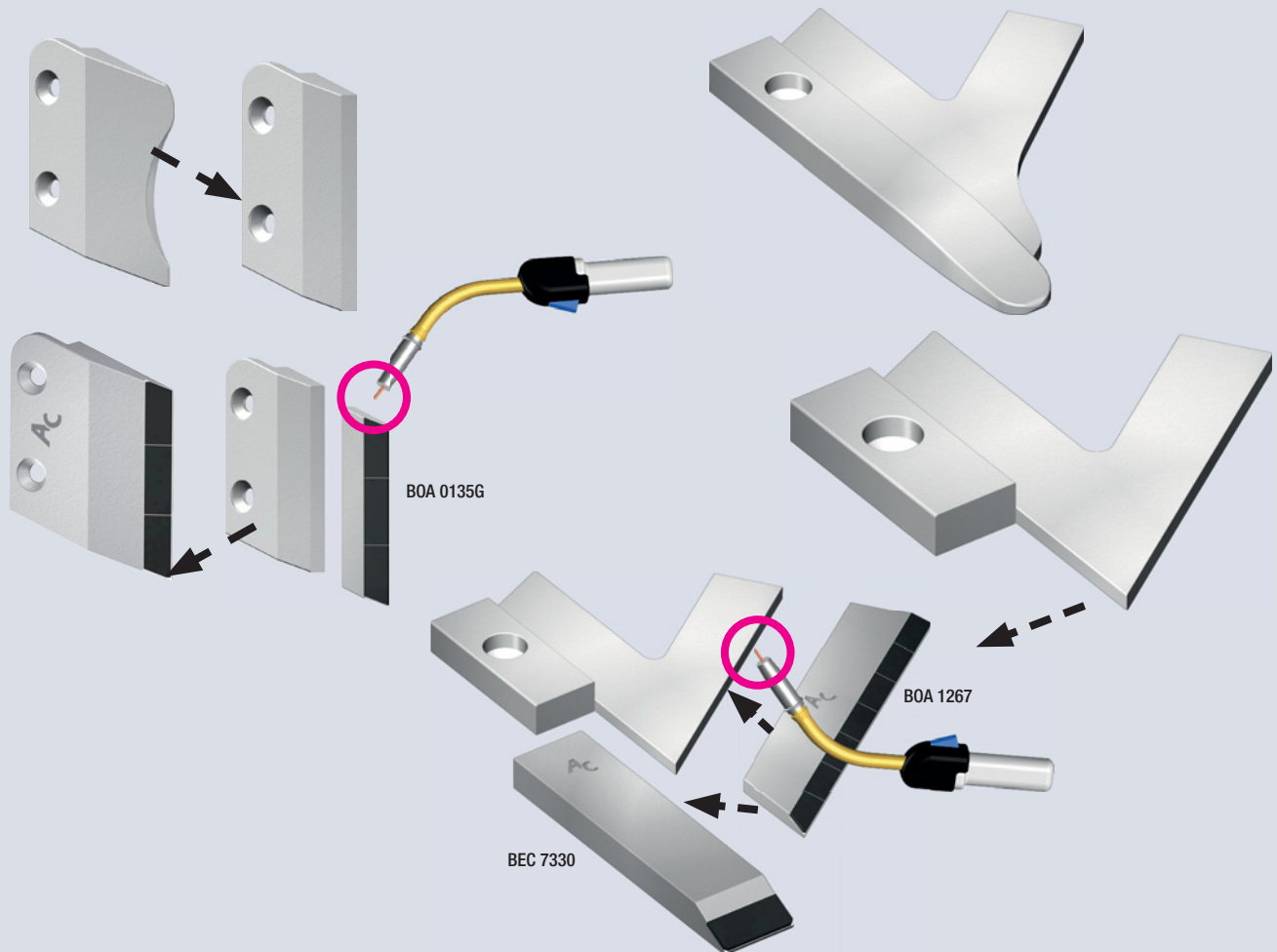
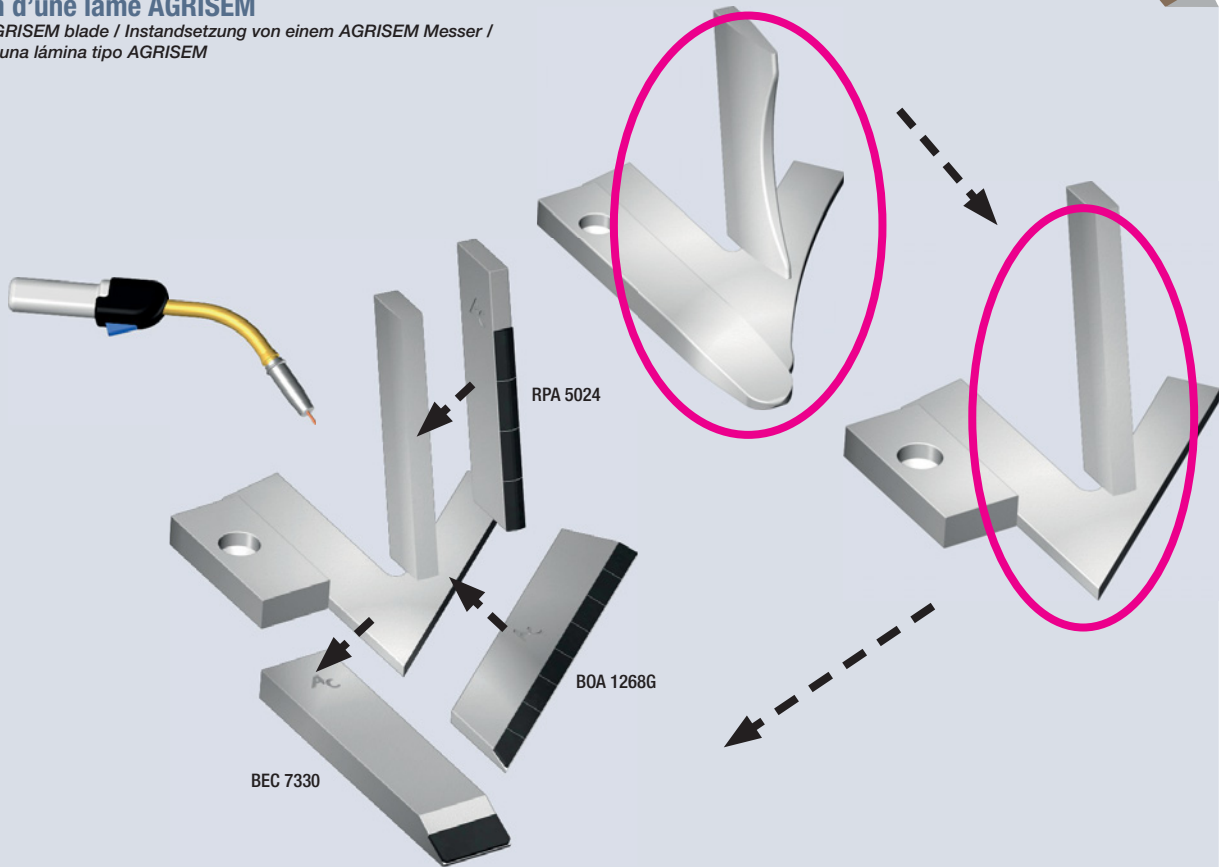

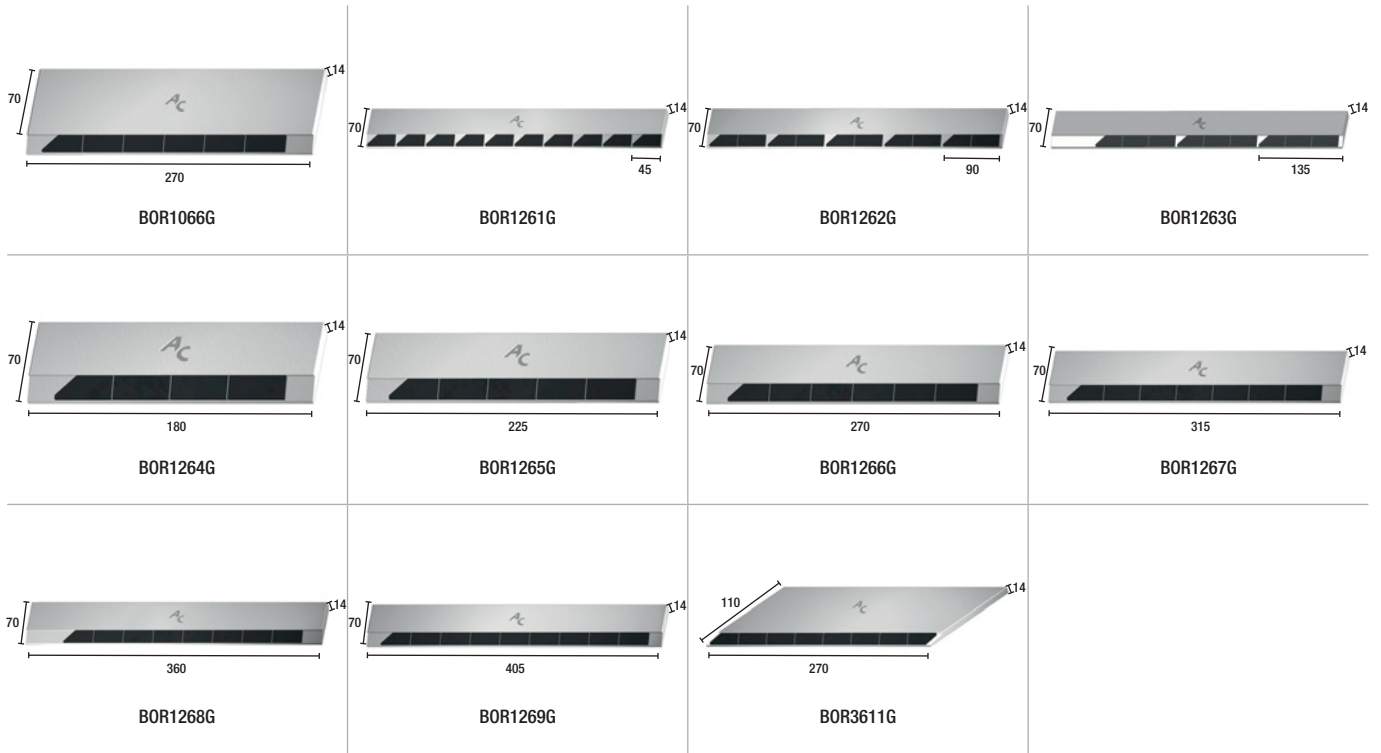

Ac		L x H x E L x H x T L x H x D L x A x E	À souder sur To weld on Anzuschweißen auf Para soldar sobre	€
◀	▶			
BOR1066G	BOR1066D	270x110x14	Universel Universal	88,56
BOR1261G	BOR1261D	45x70x14		167,86
BOR1262G	BOR1262D	90x70x14		166,47
BOR1263G	BOR1263D	135x70x14		142,08
BOR1264G	BOR1264D	180x70x14		61,42
BOR1265G	BOR1265D	225x70x14		73,77
BOR1266G	BOR1266D	270x70x14		84,24
BOR1267G	BOR1267D	315x70x14		98,30
BOR1268G	BOR1268D	360x70x14		107,06
BOR1269G	BOR1269D	405x70x14		115,83
BOR3611G	BOR3611D	355x110x14		106,20

▲ POUR DÉCHAUMAGE
 FOR CULTIVATION | FÜR STOPPELBEARBEITUNG | PARA SOBRE PUNTAS



BEC1224BG



BEC7217BG

GENRE TO FIT PASSEND FÜR TIPO	Ac		Origine	L x H x E L x H x T L x H x D L x A x E	€
	◀	▶			
Embouts à souder	BEC1224BG	BEC1224BD	Pour Soc & Bec Abgeschrägt / Biseauté / Biselado	240x100x20	73,91
	BEC1224B-RG	BEC1224B-RD		240x100x20	95,87
	BEC7217BG	BEC7217BD		170x70x20	56,12
	BEC7217B-RG	BEC7217B-RD		170x70x20	78,00

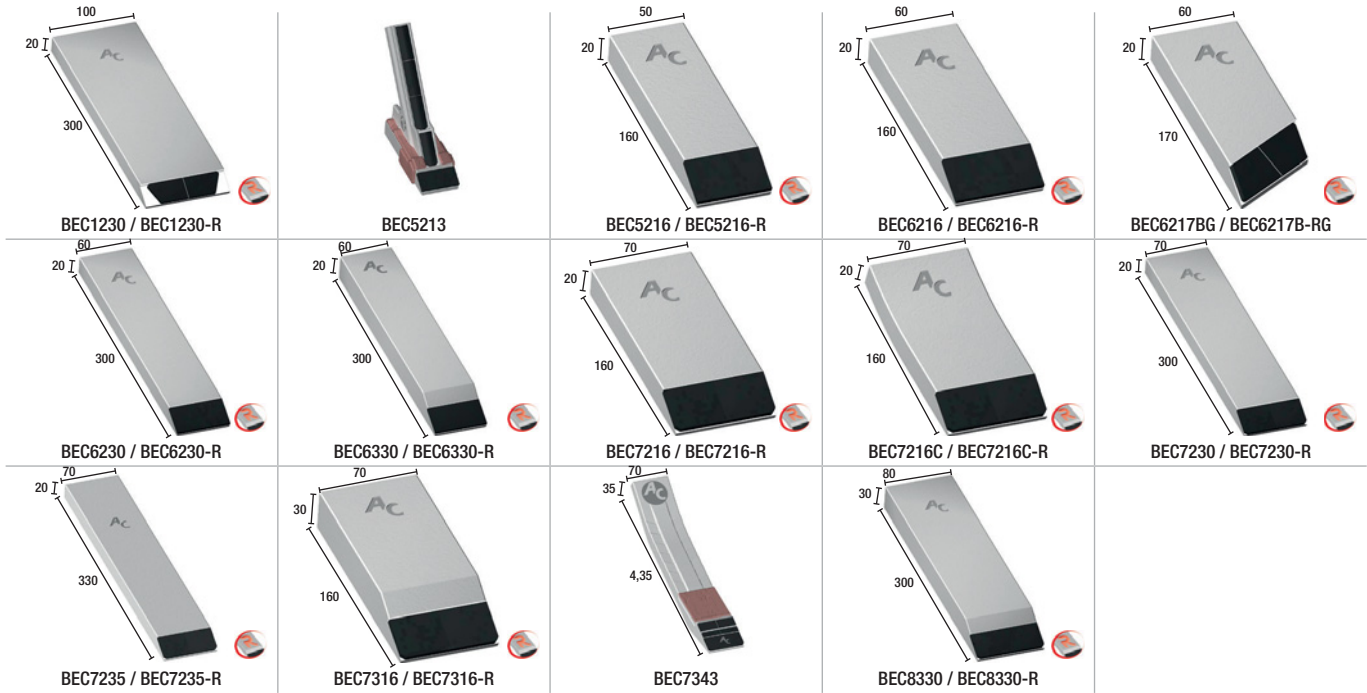

AC		Forme Shape Form Forma	L x H x E L x H x T L x H x D L x A x E	Type d'utilisation Application Passend Für / Andwendung Tipo de uso	€	
Sans rechargement					Sans rechargement Without Hardfacing Ohne hartauftrag Sin refuerzo	
BEC1230	BEC1230-R	Plat Llano / Flach / Flat	300x100x20	Décompacteur Subsoiler / Tiefenlockerer / Descompactadores	79,08	103,68
BEC5213			135x50x22		133,68	/
BEC5216	BEC5216-R	Plat Flach / Flat / Llano	160x50x20		55,40	77,26
BEC6216	BEC6216-R		160x60x20		55,69	77,56
BEC6217BG	BEC6217BD	Biseauté Abgeschragt / Biseauté / Biselado	171x60x20		55,69	77,56
BEC6217B-RG	BEC6217B-RD		171x60x20		55,69	77,56
BEC6230	BEC6230-R		300x60x20		65,15	87,03
BEC6330	BEC6330-R	Plat Flach / Flat / Llano	300x60x30		75,63	97,49
BEC7216	BEC7216-R		160x70x20		56,12	78,00
BEC7216C	BEC7216C-R	Cintré Gewölbt / Cintré / Cimbrado	160x70x20		57,81	79,70
BEC7230	BEC7230-R		300x70x20		65,60	87,46
BEC7235	BEC7235-R		350x70x20		65,60	87,46
BEC7316	BEC7316-R	Plat Flach / Flat / Llano	160x70x30		72,63	94,49
BEC7343			435x70x35		119,71	/
BEC8330	BEC8330-R		300x80x30		79,36	103,96

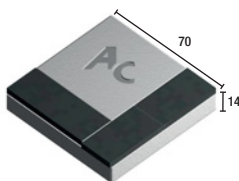

RDC0714

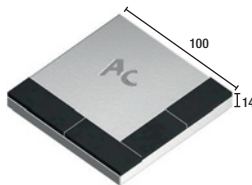

RDC1012

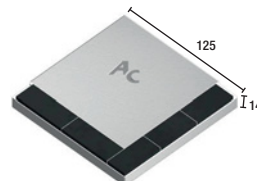

RDC1214

AC	L x H x E L x H x T L x H x D L x A x E	Type d'utilisation Application Passend Für / Andwendung Tipo de uso	€
RDC0714	70x70x14	Universel Universal	26,25
RDC1012	100x100x12		57,81
RDC1214	125x125x14		68,31



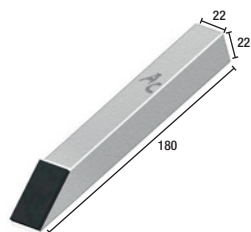

PMS2218

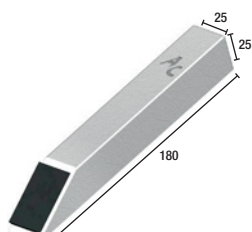

PMS2518

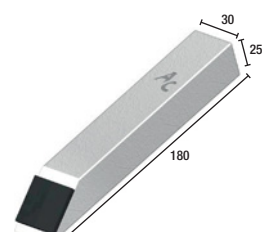

PMS3025

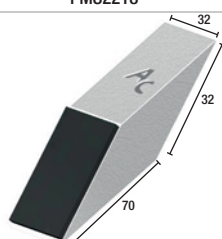

PMS3212

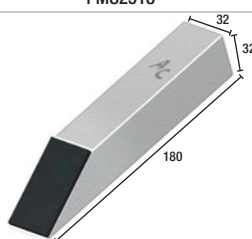

PMS3218

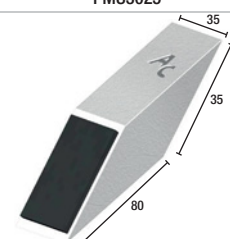

PMS3512

GENRE TO FIT PASSEND FÜR TIPO	AC	L x H x E L x H x T L x H x D L x A x E	€
Embouts à souder Weld-on points / Meißelspitzen Puntas para soldar	PMS2218	180x22x22	43,36
	PMS2518	180x25x25	51,82
	PMS3025	180x30x25	45,45
	PMS3212	70x32x32	54,06
	PMS3218	180x32x32	54,06
	PMS3512	80x35x35	54,06

▲ POUR SOCS | FOR SHARES
FÜR SCHARE | PARA REJAS DE ARADO

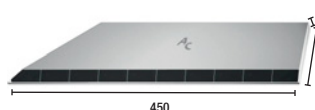

BOR0106G

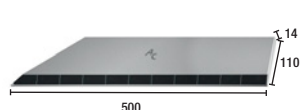

BOR0107G

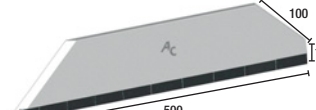

BOR0108G



BOR0126G



BOR0127G

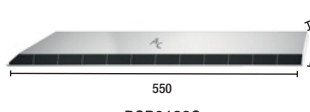

BOR0129G

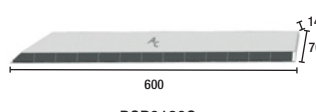

BOR0130G

AC		Origine	L x H x E L x H x T L x H x D L x A x E	À souder sur To weld on Anzuschweißen auf Para soldar sobre	€
<	>				
BOR0106G	BOR0106D	14"	450x110x14	Toutes marques All brands Alle typen Todas marcas	130,32
BOR0107G	BOR0107D	16"	500x110x14		140,51
BOR0108G	BOR0108D	-	485x110x14		160,32
BOR0126G	BOR0126D	14"	450x70x14		122,87
BOR0127G	BOR0127D	16"	500x70x14		135,06
BOR0129G	BOR0129D	20"	550x70x14		143,96
BOR0130G	BOR0130D	20"	600x70x14		156,60

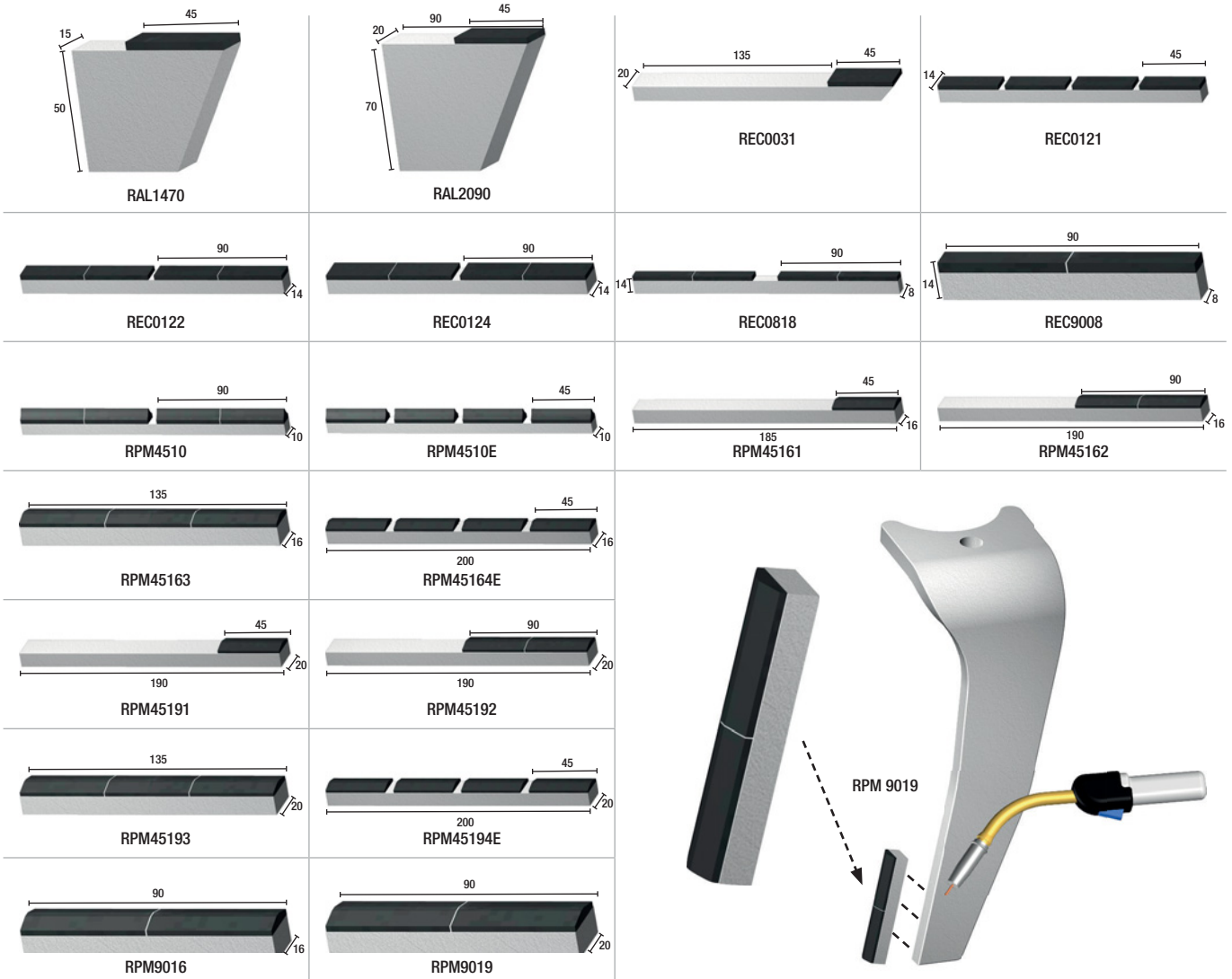

AC	Forme Shape Form Forma	L x H x E L x H x T L x H x D L x A x E	À souder sur To weld on Anzuschweißen auf Para soldar sobre	€	
RAL1470		70x50x15	Spécial Dutzi rotor	22,00	
RAL2090		70x90x20	Dutzi rotor / Dutzi rotor / Especial Dutzi rotor	28,53	
REC0031		45x20x14	Herses alternat.	15,81	
REC0121		200x14x14	Harrows with reciprocating bars / Rütleleggen / Gradas Alternat.		
REC0122	Plat Flach / Flat / Llano	185x14x14	Herses rotatives	55,40	
REC0124		185x20x14	Power Harrows / Gradas rotativas / Kreiseleggen		
REC0818		200x8x14	Rotor	24,55	
REC9008		90x14x8			
RPM4510		185x10x12			
RPM4510E		200x10x12	Profiliée Pointed Formstahl Perfi ladas	Herses rotatives Power Harrows / Gradas rotativas / Kreiseleggen	16,93
RPM45161		45x16x14			34,03
RPM45162	90x16x14	47,66			
RPM45163	135x16x14	64,86			
RPM45191	25x20x14	17,36			
RPM45192	90x20x14	34,31			
RPM45193	135x20x14	47,80			
RPM45194E	185x20x14	66,03			
RPM9016	90x14x14	33,30			
RPM9019	90x20x14	33,75			



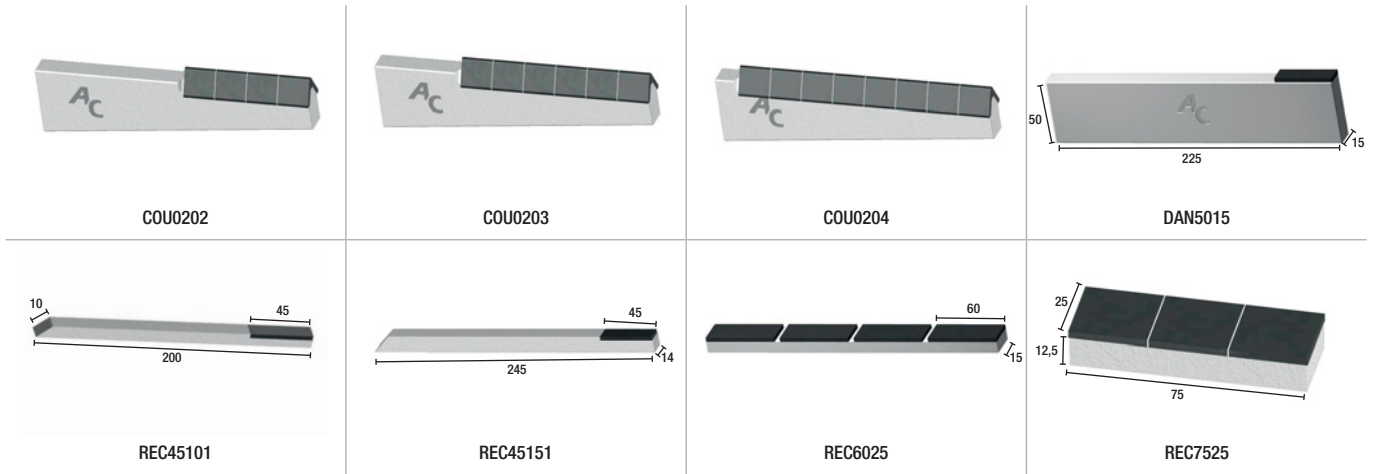

AC	L x H x E L x H x T L x H x D L x A x E	Type d'utilisation Application Passend Für / Anwendung Tipo de uso	€
COU0202	200x50x14	Coutre/Enfouissement du lisier et nitroculteurs Coulter/Slurry injector / Anlagenseche/Aussäen Reja/Enterrado de abono semilíquido & nitrocultivadores	102,99
COU0203	200x50x14		111,40
COU0204	200x50x14		155,82
DAN5015	225x50x15	Plat/Dangreville Flat/Dangreville / Flach/Dangreville / Llano/Dangreville	21,36
REC45101	200x10x10	Plat/Herses étrilles Ø6-8-10 Flat/Chain harrow / Flach/Netzegge / Llano/Gradas almohazas	14,92
REC45151	245x14x14	Plat/Herses étrilles Ø>10 Flat/Chain harrow / Flach/Netzegge / Llano/Gradas almohazas	16,35
REC6025	270x25x15	4 Plaq. Espacées/Dents RAU 4 tips separated/RAU tines / 4 platte verstreut/RAU zinken / 4 plaquetas espaciadas/Dientes RAU	136,22
REC7525	75x25x12,5	Protection pied à déchaumeur	21,90

POUR MATERIEL SPECIFIQUE | FOR SPECIFIC EQUIPMENT ▲
FÜR SPEZIELLE GERÄTE | PARA MATERIALES ESPECÍFICOS

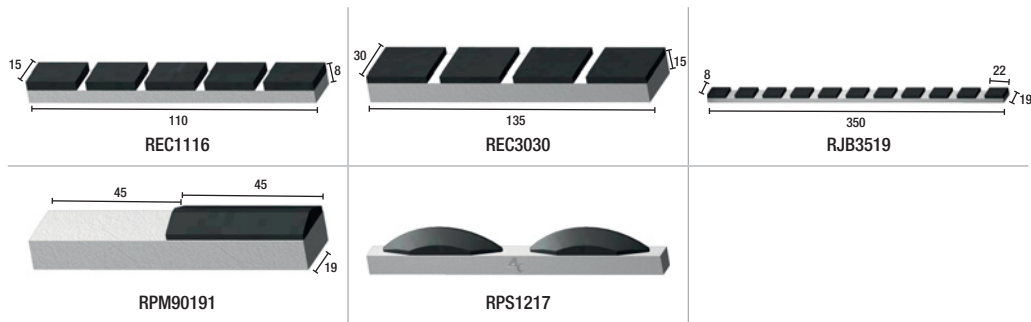

AC	L x H x E L x H x T L x H x D L x A x E	Type d'utilisation Application Passend Für / Anwendung Tipo de uso	€
REC1116	110x15x8	5 plaquettes/A souder sur sabots de semoirs 5 tips/to weld on seed coulters / 5 platte/ anzuschweißen auf Sämaschinenchare 5 plaquetas/para soldar sobre rejas de sembradoras	26,26
REC3030	135x30x15	4 Plaq. Espacées/A souder 4 tips/to weld / 4 platte/ anzuschweißen / 4 plaquetas/para soldar	80,66
RJB3519	350x19x8	11 plaquettes soleil 11 tips turbine / 11 platte siebsterne / 11 plaquetas sol	51,53
RPM90191	90x20x14	A souder sur dent RAU To weld on RAU tines / Anzuschweißen auf RAU zinken / Para soldar sobre dientes RAU	17,95
RPS1217	175x12x12	Sabots de semoirs a souder Seed coulters to weld / Sämaschinenchare/Anzuschweißen / Rejas de sembradoras para soldar	75,35



Prestation de rechargement

Welding service / Schweissleistungen / Prestación de soldadura

PSHERS / PSHERS-3



Prestation de soudage sur support externe. RPM non inclus

Cut + Weld (only service)

Schneiden + Anschweißen (nur leistungen).

Recorte + Refuerzo para diente del cliente

(unicamente prestacion).

	€
PSHERS	12,52
PSHERS-3	18,86

PSRDH-90 / PSRDH-135

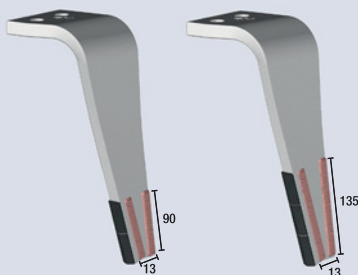

Rechargement sur dent 2-3 plaquettes

Harfacing on tires 2-3 tips

Hartauftrag auf zinken 2-3 platten

Refuerzo suplementario para 2-3 plaquetas

	€
PSRDH-90	10,09
PSRDH-135	14,68



PSRBD-80

Prestation de rechargement sur becs de déchaumeur 80 mm

Application of hardfacing on cultivator points 80 mm

Anwendung von Hartauftrag auf Grubberspitzen 80 mm

Prestación de soldadura sobre puntas de cultivador de 80mm de anchura

	€
PSRBD-80	24,77
PSRSC-33	32,14
PSRSC-70	23,36

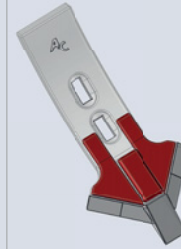

PSRSC-33

Prestation de rechargement sur socs de chisels

Application of hardfacing on Anwendung von Hartauftrag auf

Prestación de soldadura sobre rejas de chisel

SCU3312, SCU3314, SCC3312-H, SCC3314-H



PSRSC-70

Prestation de rechargement sur socs de chisels

Application of hardfacing on Anwendung von Hartauftrag auf

Prestación de soldadura sobre rejas de chisel

SCU7012, SCC7012-H, BDL4386

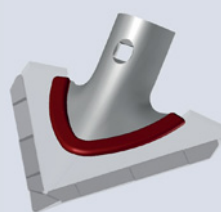

MDBO



MDRI



MDSO

PRIX SUR DEMANDE

Jusqu'à 250 mm
Up to 250 mm | Bis zu 250 mm | Hasta 250 mm

Prestation de soudage

Welding service / Umbau von Gänsefußschare / Prestación de soldadura

PSST

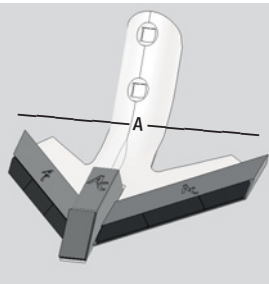

A < 100 mm : Pas de prestation
A < 100 mm : No hacemos prestación
A < 100 mm : Keine leistung
A < 100 mm : nowelding service

PSST 1020 : 100 mm ≤ A 200 mm

PSST 2030 : 200 mm ≤ A 300 mm

PSST 3040 : 300 mm ≤ A 400 mm

	€
PSST-1020	72,31
PSST-2030	86,02
PSST-3040	98,78

PRIX SUR DEMANDE

Notes

Nota | notiz | note

A series of horizontal dotted lines for writing notes, spanning the width of the page.



Boulons - Soudage Bolts-welding

Schrauben-schweißung

Tornillos-soldadura



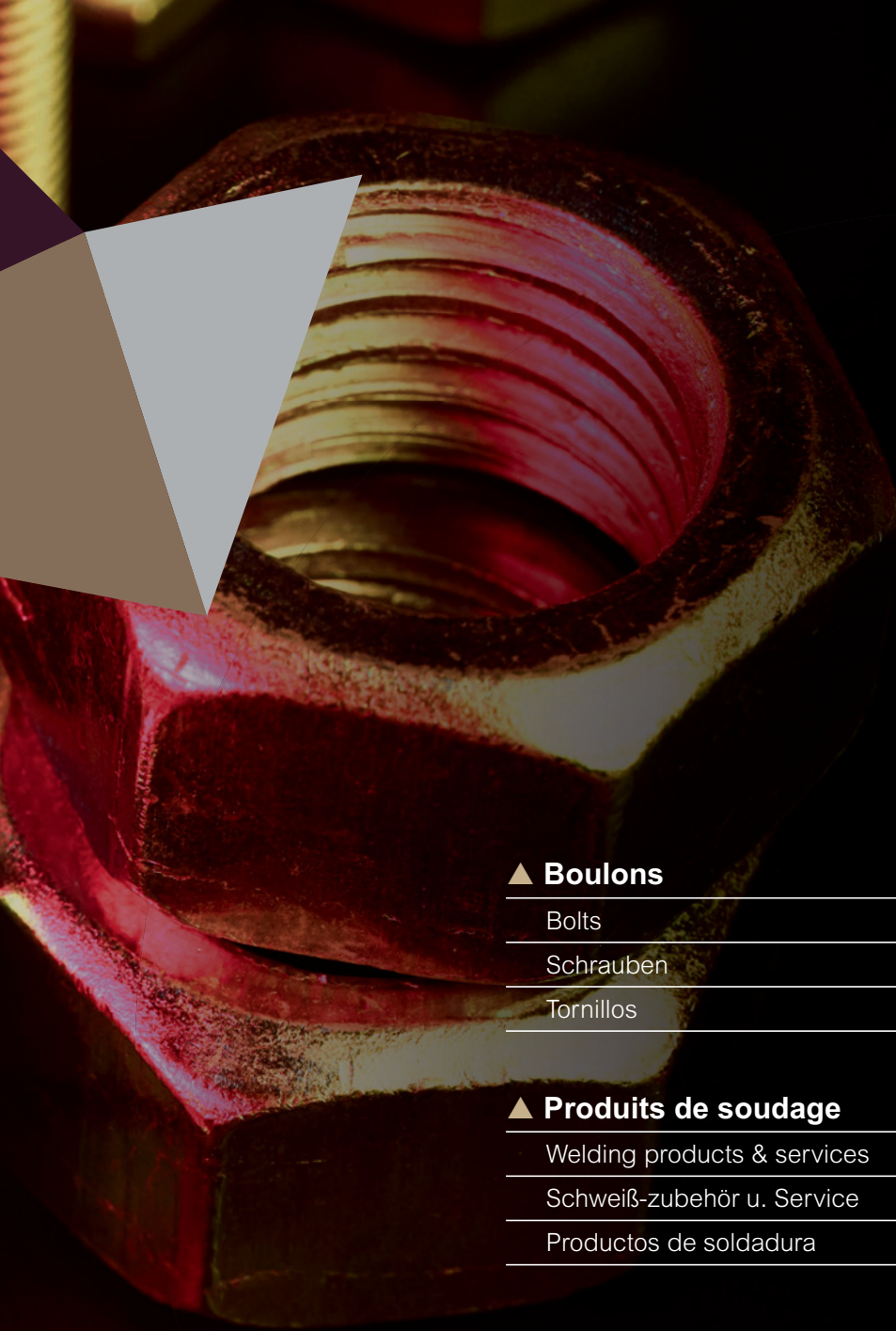

▲ **Boulons** **164**

Bolts

Schrauben

Tornillos

▲ **Produits de soudage** **169**

Welding products & services

Schweiß-zubehör u. Service

Productos de soldadura



Écrous

Bolts / Mutter / Tuercas



ACTUB 1210-22



ACTUB 1412-22



ACTUB 1714-11

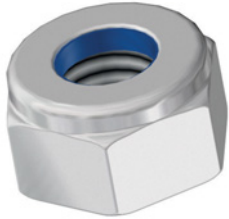

M10-Y
M14-Y
M16-Y
M18-Y
M20-Y



M14-NYEM
M16-NYEM



BTG 0800



BTG 1060

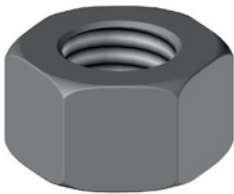

M10
M12
M14
M16
M20

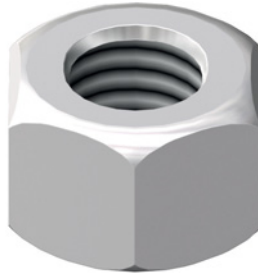

M12-OB



BEBAC 9013



BTCAC 1325

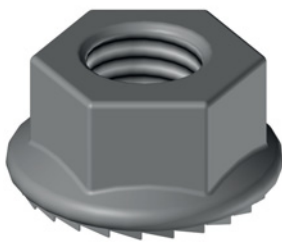

M10-EC



BTECR 14-200-19-EM
Pour montage CLC | For CLC mounting |
Für CLC Montage | Para montaje CLC



M10-ECL



M12-ECL



BTFCW

2 Ergots

2 Nib Bolts / Schrauben 2 Nasen / Doble Teton

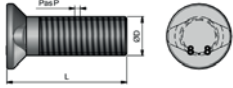

AC	Ø	L		CL		INKLUSIVE INCLUDED	INCLUS INCLUIDA	€
BTF2E1235	12	35	175	8,8	25	M12		0,97
BTF2E1440	14	40	200	8,8	25	M14		1,13
BTF2E1450	14	50	200	8,8	25	M14		1,27

Boulons Carbure

Carbide Bolts / Hartmetall Schrauben / Tornillos Carburo

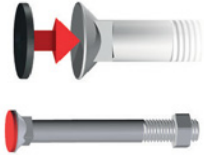

AC	Ø	L		CL		INKLUSIVE INCLUDED	INCLUS INCLUIDA	€
BTFCW-12100	12	100	175	12,9	1	M12		8,14
BTFCW-1235	12	35	175	12,9	1	M12		7,35
BTFCW-1240	12	40	175	12,9	1	M12		7,40
BTFCW-1250	12	50	175	12,9	1	M12		7,53
BTFCW-1255	12	55	175	12,9	1	M12		7,58
BTFCW-1260	12	60	175	12,9	1	M12		7,64
BTFCW-1270	12	70	175	12,9	1	M12		7,80
BTFCW-1280	12	80	175	12,9	1	M12		7,91
BTFCW-1285	12	85	175	12,9	1	M12		7,98
BTFCW-1290	12	90	175	12,9	1	M12		8,03

Boulons Spéciaux

Special Bolts / Spezielle Schrauben / Tornillos Especiales

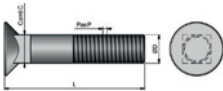

AC	Ø	L		CL		INKLUSIVE INCLUDED	INCLUS INCLUIDA	€
BTFC1250-10-ECL	10	50	150	12,9	50	M10		3,85
BTFC1270-10-EC	10	70	150	12,9	25	M10-EC		3,25
BTFC1290-10-EC	10	90	150	12,9	25	M10-EC		3,55
BTFC1460-12	12	60	200	12,9	25	M12		2,23
BTFC1490-12	12	90	200	12,9	25	M12		2,38
BTFC1640-CC	16	40	200	10,9	25	M16-CC		2,19

NEW

Entretoise

Spacer / Abstandshalter / Espaciadora

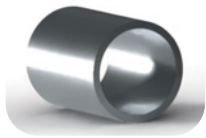

AC	Ø		L		€
ACTUB1210-22	12	2	22	1	1,00
ACTUB1412-22	14	2	22	1	1,00
ACTUB1714-11	14	2	11	1	1,50

Goupilles Pour Lame Michel

For Michel Blades / Für Michel Me_i_e / Pines Para Michel Blade



AC	Ø	L		€
BTG0800	16	60	1	4,26
BTG1060	10	60	1	4,11

Pour Actisol

For Actisol / Für Actisol / Para Actisol

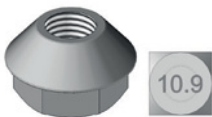





AC	Ø	L		CL		€
BEBAC9013	13		150	12,9	1	4,33
BTCAC1325	13	25	150	10,9	1	8,20
BTCAC1330	13	30	150	10,9	1	8,40

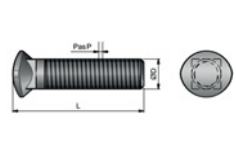

Pour Socs Vibroculteurs

For Vibrocultivator Shares / Für Vibrationseggenzinken / Para Puntas Vibrocultivadores





AC	Ø	L		CL		INCLUSIVE INCLUDED  INCLUS INCLUIDA	€
BTOCC1045-EC	10	45	150	8,8	25	M10	1,24
BTOCC1060-ECL	10	60	150	10,9	25	M10-ECL	3,07

Tete Ronde Collet Carre

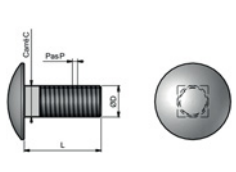
Mushroom Head Square Neck Bolts / Flachrundsrauben Mit Vierkantansatz / Cabez Redonda Cuello Cuadrado



AC	Ø	L		CL		INCLUSIVE INCLUDED  INCLUS INCLUIDA	€
BTRCC1240-OB	12	40	175	12,9	25	M12-OB	2,10
BTRCC1270-OB	12	70	175	12,9	25	M12-OB	4,10
BTRCC1280-OB	12	80	175	12,9	25	M12-OB	4,20



NEW

NEW

Tête Conique 1 et 2 Meplats

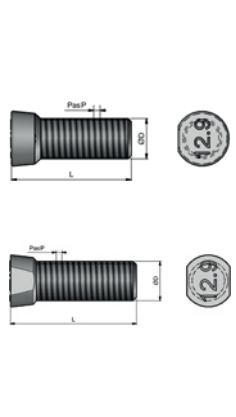
Conical Head Screws, 2 Flat Sides / Kegelschraube 2 Abflachungen / Cabeza Conica 2 Tornillos Conico-Ovalados





AC	Ø	L		CL		INCLUSIVE INCLUDED  INCLUS INCLUIDA	€
BTC2M1239	12	39	175	12,9	25	M12	0,97
BTC2M1245-OB	12	45	175	12,9	25	M12-OB	1,08
BTC2M1250	12	50	175	12,9	25	M12	1,27
BTC2M1264	12	64	175	12,9	25	M12	1,27
BTC2M1439	14	39	200	12,9	50	M14	1,45
BTC2M16115-NY	16	115	200	12,9	1	M16-NY	10,38
BTC2M1690-NY	16	90	200	12,9	1	M16-NY	10,08
BTC1M1434	14	34	200	12,9	25	M14	1,46
BTC1M1440-ES	14	40	200	12,9	25	M14-19	1,59
BTC1M1440-NY	14	40	200	12,9	25	M14-NY	1,45

Tête Hc Cylindrique 6 Pans Creux

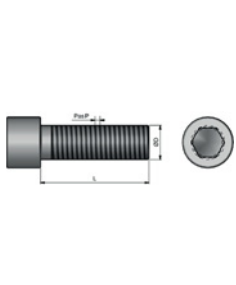
Hexagon Socket Head Cap Screws / Zylinderschrauben Mit Innensechskant / Cabeza Cilindrica



AC	Ø	L		CL		INCLUSIVE INCLUDED  INCLUS INCLUIDA	€
BTCHC12150	12	150	150	12,9	25	-	4,95
BTCHC1225	12	25	150	12,9	25	-	4,35
BTCHC1435	14	35	150	12,9	25	-	3,89
BTCHC1445	14	45	150	12,9	25	-	4,35
BTCHC1670	16	70	150	12,9	25	-	4,77
BTCHC1680	16	80	200	12,9	25	-	5,02



NEW

NEW

Tête Hc Pour Decompacteurs

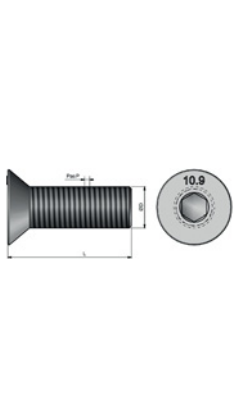
For Michel Blades / Für Michel Me_i / Cabeza Hc Para Subsolador



AC	Ø	L		CL		INCLUSIVE INCLUDED  INCLUS INCLUIDA	€
BTFHC1025	10	25	150	10,9	25	M10	1,35
BTFHC1225	12	25	175	10,9	25	M12	1,91
BTFHC14130-NY	14	130	200	10,9	25	M14-NY	5,98
BTFHC1440	14	40	200	10,9	25	M14	4,11
BTFHC1490-NY	14	90	200	10,9	25	M14-NY	4,88
BTFHC1635-150	16	35	150	10,9	1	M16	5,82
BTFHC1645-NY	16	45	200	10,9	50	M16-NY	6,53
BTFHC20120	20	120	250	10,9	25	M20	12,72
BTFHC2060	20	60	250	10,9	25	M20	9,21

Tête Fraisée Collet Carré

Countersunk Head Square Neck Bolts / Senkschrauben Mit Vierkantansatz / Cabeza Avellanada Cuello Cuadrado

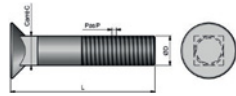

AC	Ø	L	P	CL		INCLUSIVE INCLUDED INCLUS INCLUIDA	€
BTFC1035	10	35	200	8,8	25	M10	1,05
BTFC1040	10	40	150	12,9	25	M10	1,10
BTFC1050	10	50	150	12,9	25	M10	1,15
BTFC1050-ECL	10	50	150	12,9	25	M10-ECL	3,35
BTFC1060-ECL	10	60	150	10,9	25	M10-ECL	3,40
BTFC1060-NY	10	60	150	10,9	25	M10-NY	1,84
BTFC1070-ECL	10	70	150	12,9	25	M10-ECL	3,52
BTFC1070-NY	10	70	150	12,9	50	M10-NY	2,09
BTFC12100	12	100	175	12,9	25	M12	1,75
BTFC12120	12	120	175	12,9	25	M12	4,95
BTFC1235	12	35	175	12,9	25	M12	1,10
BTFC1235GB	12	35	125	10,9	25	M12	1,27
BTFC1240	12	40	175	12,9	25	M12	1,15
BTFC1250	12	50	175	12,9	25	M12	1,21
BTFC1255	12	55	175	12,9	25	M12	1,27
BTFC1260	12	60	175	12,9	25	M12	1,35
BTFC1270	12	70	175	12,9	25	M12	1,46
BTFC1280	12	80	175	12,9	25	M12	1,59
BTFC1285	12	85	175	12,9	25	M12	1,64
BTFC1290	12	90	175	12,9	25	M12	1,69
BTFC14100	14	100	200	12,9	25	M14	2,22
BTFC1440	14	40	200	12,9	25	M14	1,27
BTFC1450-NY	14	50	200	12,9	25	M14-NY	2,58
BTFC1460	14	60	200	12,9	25	M14	2,10
BTFC1470-NY	14	70	200	12,9	25	M14	2,08
BTFC1480	14	80	200	12,9	25	M14	2,19
BTFC1490	14	90	200	12,9	25	M14	2,32
BTFC16115-NY	16	115	200	10,9	25	M16-NY	4,72
BTFC1660-NY	16	60	200	10,9	25	M16-NY	2,97
BTFC1670-NY	16	70	200	10,9	25	M16-NY	3,26
BTFC1690-NY	16	90	200	10,9	25	M16-NY	3,84

NEW

Tête Hexagonale

Hexagonal Head / Sechskantschrauben / Cabeza Hexagonal

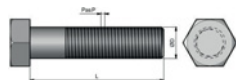

AC	Ø	L	P	CL		INCLUSIVE INCLUDED INCLUS INCLUIDA	€
BTHEX1025-NY	10	25	150	12,9	50	M10	2,36
BTHEX1235-OB	12	35	150	12,9	50	M12-OB	3,04
BTHEX1240-125-NY	12	40	125	10,9	50	M12-NY	3,22
BTHEX1250-OB	12	50	175	10,9	25	M12-OB	4,60
BTHEX1260-OB	12	60	175	10,9	25	M12-OB	4,65
BTHEX1270-OB	12	70	175	10,9	25	M12-OB	4,77
BTHEX1280-OB			175	10,9	25	M12-OB	4,85
BTHEX1290-OB	12	90	175	10,9	25	M12-OB	4,90
BTHEX1435-150-NY	14	35	150	10,9	25	M14-NY	2,33
BTHEX1440-150-NYEM	14	40	150	10,9	25	M14-NYEM	2,60
BTHEX1450-150-NYEM	14	50	150	12,9	25	M14-NYEM	2,70
BTHEX1460-150-NYEM	14	60	150	12,9	25	M14-NYEM	2,84
BTHEX1640-200-NY	16	40	200	8,8	25	M16-NY	4,74
BTHEX1655-150-NYEM	16	55	150	12,9	25	M16-NYEM	5,03
BTHEX1660-150-NYEM	16	60	150	12,9	25	M16-NYEM	4,79
BTHEX1670-150-NYEM	16	70	150	10,9	25	M16-NYEM	5,16
BTHEX1680-200-EC	16	80	200	10,9	25	M16-EC	6,25
BTHEX1860-150-NY	18	60	150	10,9	25	M18-NY	5,89
BTHEX2060-150-NY	20	60	150	10,9	25	M20-NY	5,47

NEW
NEW

NEW



Barres de Rechargement

Welding Bars / Schweißungstange / Barras De Recarga

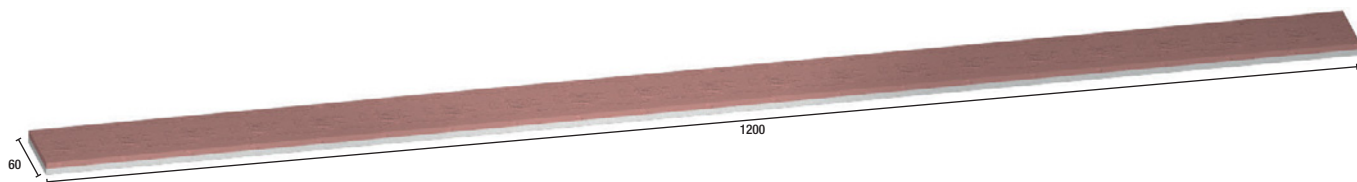

BRC12060

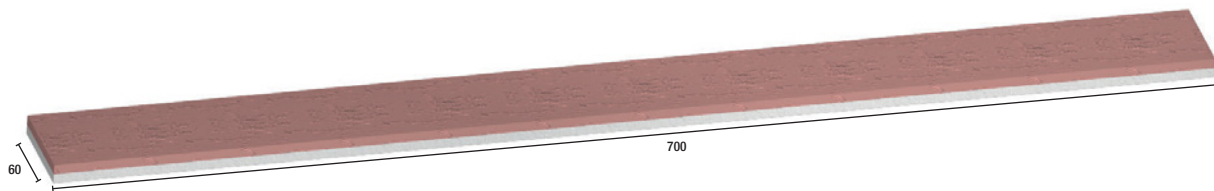

BRC7060

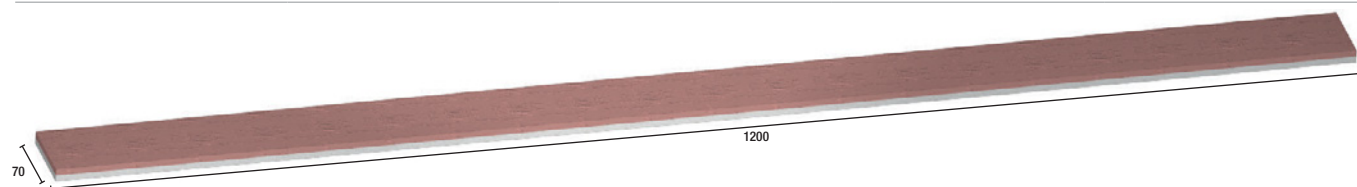

BRC12070

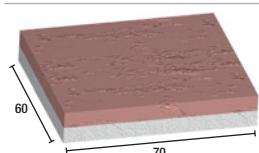

BRC0760

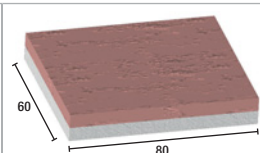

BRC0870

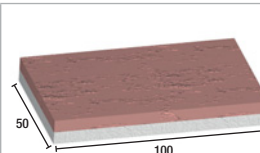

BRC1050

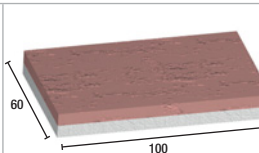

BRC1060

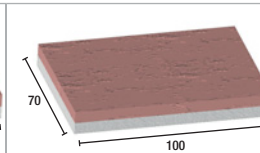

BRC1070

AC	↔	#	€
BRC0760	70x60x12	Barre à souder <i>Barra a soldar Schweißungstange Welding bar</i>	10,99
BRC0870	80x70x12		17,66
BRC1050	100x50x12		13,89
BRC1060	100x60x12		15,69
BRC1070	100x70x12		17,66
BRC12060	1200x60x12		159,21
BRC12070	1200x70x12		185,82
BRC7060	700x60x12		92,93

Electrodes

Rods / Elektrode / Electrodo

Recommandé par Agricarb
Recommended by / Recomendado por
Agricarb | Empfohlen von



ELA0035



ELR6320

AC	↔	#	kg/📦	€/kg	€/📦
ELA0035	3,2x350	Electrode d'assemblage acier inox, haute qualité (2 kg/pack) High quality stainless steel assembly electrode (2kg/pack) Schweißelektrode Edelstahl ; hohe Qualität (2kg/pack) Electrodo de ensamble de acero inoxidable, alta calidad (2kg/pack)	2	64,10	128,20
ELR6320	6x450	Electrode de rechargement : Forte résistance à l'abrasion (2 kg/pack - 58/62HRC) Reloading electrode: High abrasion resistance (2 kg/pack - 58/62HRC) Hartauftragungs-Elektrode; Hohe Verschleißfestigkeit (2 kg/pack - 58/62HRC) Electrodo de recarga. Alta resistencia al desgaste (2 kg/pack - 58/62HRC)	2	88,60	177,20

Fil

Welding Wire / Drahtschweißung / Hilos



FABSR10-12

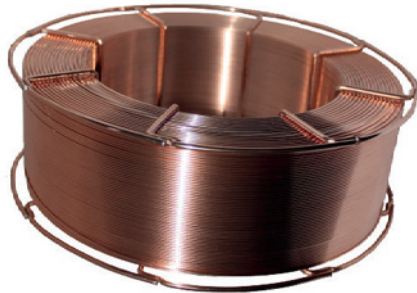

FRBXR05-12

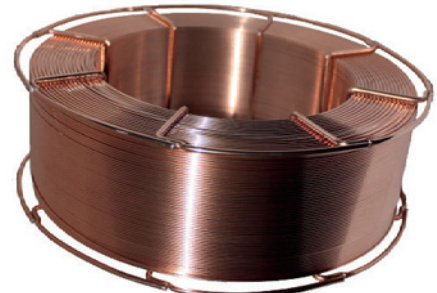

FRBXR15-16

AC	↔	#	kg/📦	€/kg	€/📦
FABSR10-12	Ø12	Fil d'assemblage haute qualité (Ø1,2 - 15 kg) High quality assembly wire (Ø1,2 - 15kg) Schweißdraht, hohe Qualität (Ø1,2 - 15kg) Alambre de ensamble de alta calidad (Ø1,2 - 15kg)	15	9,87	148,09
FRBXR05-12	Ø1,2 - 62/67HRC	Fil de rechargement - Forte résistance à l'abrasion (62/67HRC) Reloading wire - High abrasion resistance (62/67HRC) Nachladefaden - Hohe Verschleißfestigkeit (62/67HRC) Alambre de recarga - Alta resistencia al desgaste (62/67HRC)	5	45,61	228,05
FRBXR15-12	Ø1,2 - 62/67 HRC		15	41,46	621,98
FRBXR15-16	Ø1,6 - 62/67HRC		15	41,46	621,98



1. APPLICATION & OPPOSABILITE

Les présentes conditions générales de vente (ci-après les « CGV ») s'appliquent à toutes les ventes de produits par AGRICARB à des acheteurs professionnels (ci-après le(s) « Client(s) »), quelles que soient les clauses pouvant figurer sur les documents du Client.

Le fait pour le Client de passer commande auprès d'AGRICARB implique l'adhésion pleine, entière et sans réserve aux présentes CGV ainsi qu'aux Conditions Générales d'Utilisation du site internet AGRICARB pour les commandes en ligne. Sauf stipulations contraires expresses entre les parties, les présentes CGV prévalent sur tout autre document et notamment sur toutes conditions générales d'achat du Client.

Les présentes CGV constituent le socle unique de la négociation commerciale entre les Parties, conformément à l'article L.441-6 du Code de commerce.

2. COMMANDES

La vente n'est parfaite et le contrat formé (ci-après le « Contrat ») qu'après l'acceptation expresse et par écrit par AGRICARB de la commande du Client matérialisée par un accusé de réception à la demande du Client ou à défaut par l'exécution de la commande par Agricarb. La commande ne peut pas être annulée (résolution) par le Client sauf acceptation préalable et écrite d'AGRICARB.

Toutes les commandes, et leurs compléments éventuels, doivent être formulés par le Client par écrit (fax, courrier ou courriel) ou sur le site internet d'AGRICARB via l'espace personnel du Client. Aucune commande ne saurait être acceptée par téléphone ou par voie orale.

Les compléments de commande (ajout de produit) sur un reliquat seront enregistrés comme une nouvelle commande et fera l'objet de nouveaux frais de port. Celle-ci ne sera considérée comme acceptée que par une confirmation écrite d'AGRICARB.

Les caractéristiques contractuelles des produits sont celles qui figurent sur l'offre d'AGRICARB et/ou sur le bon de commande accepté par les deux parties.

Le Client dispose d'un délai de 7 jours à partir de la date de réception pour effectuer une réclamation sur les vices apparents et/ou sur la non-conformité des produits (ne concerne pas la livraison) par rapport à la commande (notamment quantité ou références erronées). Au-delà de ce délai, les produits livrés seront réputés conformes aux termes de la commande et aucune réclamation portant sur les vices apparents ou sur la conformité des Produits livrés ne pourra être effectuée.

Les ventes sont soumises aux présentes CGV, dont le Client déclare avoir préalablement pris connaissance.

3. PRIX ET REMISES

Les prix applicables sont ceux en vigueur au jour de la passation de la commande par le Client et/ou ceux mentionnés dans l'offre de prix remise par AGRICARB au Client pour la seule durée de validité de cette offre. AGRICARB se réserve la possibilité de modifier ses tarifs à tout moment, après information préalable du Client, sous réserve des Contrats en cours. Toute modification tarifaire sera automatiquement applicable à la date indiquée sur le tarif.

Sauf stipulation expresse convenue entre AGRICARB et le Client, nos prix s'entendent toujours hors taxes, produits non emballés, départ usine Ex Works (CCI 2010). Les prix n'incluent donc pas les frais de chargement, transport, déchargement, douanes et assurances, qui sont supportés par le Client. Tout impôt et/ou taxe dû en application du droit français, et notamment la TVA au taux en vigueur à la date d'émission de la facture, sont à la charge du Client.

La remise accordée par AGRICARB au Client est déterminée selon la base du prix public en vigueur.

Ce taux de remise est défini par AGRICARB en fonction notamment du chiffre d'affaires réalisé l'année précédente, de la valorisation des produits AGRICARB en magasin ainsi que de l'historique commercial entretenu entre le Client et notre société, selon le tableau annexé le cas échéant aux présentes CGV.

Le taux de remise est révisé chaque année.

Les conditions commerciales de vente sont individuelles et confidentielles.

4. LIVRAISON

Sauf accord contraire entre les parties, la livraison est réputée effectuée lors de la mise à disposition des produits au Client dans les locaux d'AGRICARB conformément à l'incoterm Ex-Works - CCI 2010 – (ci-après la « Livraison »).

LE PORT NORMAL EST APPLIQUE PAR DEFAUT, SI VOUS SOUHAITEZ UN PORT EXPRESS, VEUILLEZ CONTACTER LE MAGASIN AVEC VOTRE NUMERO DE COMMANDE AU +33 (0)4 78 04 28 47.

Il peut être convenu entre AGRICARB et le Client soit d'un forfait de départ usine selon le tableau mentionné dans les Conditions Commerciales de Vente, soit d'un franco de port et d'emballage selon le tableau mentionné dans les Conditions Commerciales de Vente, soit d'un Franco sur reliquat.

Les délais de livraison sont donnés à titre indicatif et ne pourront donner lieu à un quelconque dédommagement ou pénalité.

Agricarb n'effectue pas de livraison directe chez l'utilisateur.

Procédure litige Livraison :

- **Le Client dispose d'un délai de quarante-huit (48) heures à partir de la date de « Livraison » pour effectuer une réclamation auprès du service client Agricarb : +33 (0)4 78 04 28 47 ou magasin@agricarb.com**



- **Le client doit indiquer des réserves précises, significatives et complètes sur le document de transport. Les réserves doivent porter sur la marchandise et l'état apparent des colis. Plus les réserves sont précises, plus elles seront incontestables et faciliteront une indemnisation rapide.**

Informations obligatoires pour la réclamation :

- Notifier si « risque de manquant » et « palette reçue verte et endommagée »
- N° de colis / N° de commande
- Nombre de palette endommagées ou manquantes (ex : sur 3 palettes reçues, 1 endommagée)
- Si produit manquant : référence produit

Toute réclamation hors délai ou non complète ne sera pas prise en compte.

5. CONDITIONS DE REGLEMENT

Pour la première commande, le paiement se fera avant la livraison.

Pour toutes les factures, le règlement aura lieu dans un délai maximum de 30 jours fin de mois étant précisé que le délai court à compter de la date d'émission de la facture, la limite de paiement intervenant à la fin du mois au cours duquel expirent ces 30 jours.

Aucun escompte n'est accordé au Client en cas de paiement anticipé.

Le règlement par le Client des sommes dues postérieurement à la date d'exigibilité figurant sur la facture entraîne de plein droit l'application d'une indemnité forfaitaire de 40€ (articles L441-6 alinéa 12 et D441-5 du code de commerce). En cas de modification légale et/ou réglementaire de cette indemnité forfaitaire, le nouveau montant sera de plein droit substitué à celui figurant dans les présentes CGV. L'application de plein droit de cette indemnisation ne fait pas obstacle à l'application d'une indemnité complémentaire de la créance sur justification, conformément au

texte susvisé, a dû concurrence de l'intégralité des sommes qui auront été exposées par AGRICARB, qu'elle qu'en soit la nature, pour le recouvrement de créance.

En cas de retard de paiement, le montant des sommes dues sera majoré d'une pénalité de retard égale à trois (3) fois le taux d'intérêt légal par mois à partir de la date d'échéance.

AGRICARB se réserve le droit d'effectuer des livraisons en contre remboursement.

Le règlement d'une facture doit être effectué en totalité, les éventuels avoirs ou autres déductions (garantie ...) accordés seront enregistrés après l'envoi d'un document comptable par AGRICARB.

En cas de non-respect par le Client des présentes conditions de règlement, AGRICARB se réserve le droit de suspendre les livraisons des commandes en cours ou de résilier le Contrat de plein droit, avec effet immédiat, sans préjudice de toute autre action qu'AGRICARB serait en droit d'intenter.

6. GARANTIES

Les produits livrés par AGRICARB bénéficient d'une garantie contractuelle de six (6) mois à partir de la date de Livraison.

La garantie contractuelle s'applique uniquement sur un défaut technique des plaquettes en carbure.

Aucune garantie ne sera acceptée par AGRICARB en cas de mauvaise utilisation, de négligence ou de défaut d'entretien de la part du Client.

L'usure, la casse ou le pliage de la pièce sont expressément exclus de la garantie.

En outre, toute pièce ayant subi une modification à l'initiative du Client et/ou d'un tiers par rapport à la fabrication originale n'entre pas dans le cadre de la garantie (Rechargement, soudage...).

Seules les pièces montées avec une boulonnerie fournie par AGRICARB sont couvertes par la garantie.

Seuls les supports encadre pourvus de carbure feront l'objet d'une étude de prise en garantie.

Aucun retour de marchandise ne sera accepté sans notre accord préalable (Consultation de notre équipe commerciale et technique). En cas d'accord, le retour usine s'effectuera, par transporteur, à la charge et aux risques du Client.

Après examen, la société AGRICARB sera seul juge du constat de vice de fabrication.

Le cas échéant, la ou les pièces prises en garantie seront remplacées par une pièce semblable ou équivalente, aucun avoir ne sera accordé par AGRICARB.

7. RESPONSABILITES

La responsabilité totale d'AGRICARB est limitée aux seuls dommages matériels et corporels directs causés au Client et imputables exclusivement aux produits et/ou à une inexécution contractuelle d'AGRICARB. La responsabilité d'AGRICARB du fait des produits vendus au Client est expressément exclue pour tous les dommages indirects et/ou immatériels, consécutifs ou non consécutifs, subis par le Client et/ou par un tiers, tels que notamment les pertes d'exploitation, de chiffre d'affaires, de commandes, de clientèle, perte d'image, etc. de sorte qu'AGRICARB ne devra aucuns dommages-intérêts à ce titre.

La responsabilité d'AGRICARB du fait des produits vendus, ayant causé un dommage au Client ou à un tiers, est expressément exclue en cas de mauvaise utilisation, négligence, ou défaut d'entretien de la part du Client, comme en cas d'usure normale du produit ou de Force Majeure (tel que définie à l'article 11), de sorte qu'AGRICARB ne devra aucuns dommages-intérêts à ce titre.

8. REPRISES PIECES

Les reprises de pièces invendues du catalogue feront l'objet d'une décote de 20 à 50 %.

Les reprises de pièces spécifiques (hors catalogue en vigueur) feront l'objet d'un chiffrage au préalable.

9. RESERVE DE PROPRIETE

Les produits objets Contrat sont vendus avec une clause subordonnant expressément le transfert de leur propriété au paiement intégral du prix en principal et accessoires. En conséquence, en cas de défaut de paiement, AGRICARB pourra reprendre possession des produits livrés, sans préjudice de toute autre action qu'AGRICARB serait en droit d'intenter.

Il est toutefois entendu que la simple remise d'un titre créant une obligation à payer, traite ou autre, ne constitue pas un paiement au sens de la présente clause, la créance originaires d'AGRICARB sur le Client subsistant avec toutes les garanties qui y sont attachées, y compris la réserve de propriété jusqu'à ce que ledit effet de commerce ait été effectivement payé.

Les dispositions ci-dessus ne font pas obstacle dès la Livraison (cf. art 4) des produits, au transfert au Client des risques de perte ou de détérioration des produits soumis à réserve de propriété ainsi que des dommages qu'ils pourraient occasionner.

Le Client devra souscrire une assurance garantissant les risques nés à compter de la Livraison des marchandises.

Tant que le prix n'aura pas été intégralement payé, le Client devra individualiser les marchandises livrées au titre du présent Contrat. Les matériels en stock sont présumés être ceux impayés.

En cas de saisie, ou de toute autre intervention d'un tiers sur les marchandises propriété d'AGRICARB, le Client devra impérativement en informer AGRICARB sans délai afin de lui permettre de s'y opposer et de préserver ses droits.

Le Client s'interdit en outre de donner en gage ou de céder à titre de garantie la propriété des marchandises.

Le Client est autorisé, dans le cadre de l'exploitation normale de son établissement, à revendre les marchandises objet du présent Contrat.

Toutefois, il s'oblige, en cas de revente alors que le prix n'a pas été réglé à l'échéance, à régler immédiatement le solde du prix restant dû à AGRICARB ou à informer les sous-acquéreurs que lesdites marchandises font l'objet d'une clause de réserve de propriété et à avertir AGRICARB de cette cession afin qu'AGRICARB puisse préserver ses droits et, le cas échéant, exercer une revendication sur le prix de revente à l'égard du sous-acquéreur.

10. PROPRIETE INTELLECTUELLE

Tous les documents techniques remis aux Clients demeurent la propriété exclusive d'AGRICARB, seul titulaire des droits de propriété intellectuelle sur ces documents.

De même, les droits de propriété intellectuelle relatifs aux produits restent la propriété pleine et entière d'AGRICARB ou des titulaires de ces droits. Seul est concédé au Client, à titre personnel, non exclusif et non transférable, un droit d'usage de ces droits de propriété intellectuelle, limité à un usage des produits et des documents techniques internes à l'entreprise du Client, pour la France et pour la durée de vie du produit. Le Client s'engage à ne faire aucun usage de ces documents susceptible de porter atteinte aux droits de propriété industrielle ou intellectuelle d'AGRICARB.

11. FORCE MAJEURE

AGRICARB ne sera pas responsable des retards et/ou inexécutions dus à des cas de force majeure, telle que définie par l'article 1218 du Code civil, ou en cas de grève du personnel d'AGRICARB, même si cet événement ne revêt pas les caractères légaux ou jurisprudentiels de la force majeure (ci-après la « Force Majeure »). En outre, les obligations d'AGRICARB envers le Client seront suspendues en cas de Force Majeure jusqu'à la cessation dudit cas de Force Majeure.

12. DROIT APPLICABLE & LITIGES

Les présentes CGV et le Contrat sont régis par le droit français. L'application de l'ensemble des dispositions de la Convention de Vienne du 11 avril 1980 relative aux contrats de vente internationale de marchandises est expressément exclue.

En cas de difficulté ou de litige concernant la validité, l'interprétation, et/ou l'exécution des présentes CGV, les parties s'efforceront de résoudre leurs différends à l'amiable. En cas de désaccord persistant, le litige sera porté devant le tribunal de commerce de Lyon.

1. APPLICATION & OPPOSABILITY

The present General Terms of Sales apply to all product sales by AGRICARB to professional buyers (hereafter the "Customer(s)"), regardless of the clauses stated in the Customer's documents.

The Customer placing an order with AGRICARB implies that they unreservedly and fully agree with the present Terms of Sales, as well as the Terms of Sales of our AGRICARB website for those Customers placing their orders via our website.

Unless otherwise expressly agreed between the parties, the present Terms of Sales prevail over any other document, particularly over the Customer's General Terms of Purchase.

These General Terms of Sales constitute the sole base of commercial negotiation between the Parties, according to Article L.441-6 of the French Commerce Code.

2. ORDERS

The sale is agreed upon and the contract deemed as formed (hereafter referred to as the "Contract") only when AGRICARB has expressly agreed to the Customer's order in writing, in the form of an order confirmation sent to the Customer upon their demand, or, failing that, by AGRICARB carrying out the order to completion. The order may not be canceled by the Customer unless otherwise expressly agreed to in writing by AGRICARB.

All orders and potential additions to those orders shall be submitted by the Customer in writing (fax, post or email) or through the Customer's personal account on the AGRICARB website. No orders formulated orally, in person or over the phone, shall be taken into account.

The addition of further references to backorders will be considered as agreed upon only if expressly accepted in writing by AGRICARB and will be processed as new orders ; as such, freight costs will apply.

The contractual characteristics of the products are those stated on AGRICARB's price offers and/or on the purchase orders, accepted by both parties.

The Customer has 7 days, starting from the delivery date, to report a claim regarding visible defects and/or the non-conformity of the goods (not including the delivery of the goods) with respect to their order (particularly in case of the wrong products or quantities being received). After this deadline, the products received by the Customer will be considered as conform to the order's terms and no claims with regards to visible defects and/or the conformity of the delivered goods will be receivable.

All sales are submitted to these General Terms of Sales, which the Customer declares to have acknowledged and accepted.

3. PRICING AND DISCOUNTS

The applicable prices are those in effect at the time the order is placed by the Customer and/or those displayed on the offer given to the customer by AGRICARB, only for the duration of validity of said offer. AGRICARB reserves itself the possibility to modify their price list at any time, with prior notice to the Customer, should the existing Contracts allow it. Any tariff change will be automatically applicable starting from the date indicated on the new pricing.

Unless otherwise expressly agreed upon between AGRICARB and the Customer, AGRICARB's prices are always indicated exclusive of taxes, for unpacked pieces, EX-WORKS (CCI 2010). Hence, prices do not include the costs related to loading, freight, unloading, customs, insurance, all of which are supported by the Customer. Any tax incurred by French law, particularly the VAT at the rate applicable on the date the invoice was issued, will be borne by the Customer.

The discounts granted to the Customer by AGRICARB are determined based upon the current public prices.

The discount rates are granted by AGRICARB notably as a function of the Customer's turnover over the last period, as well as the value of AGRICARB's products in stores, and the historic commercial relationship between the Customer and AGRICARB (where appropriate, see appended table).

The discount rate is subject to yearly revision.

The trade conditions are individual and confidential.

4. DELIVERY

Unless otherwise expressly agreed between the Parties, the delivery is considered as successful once the products have been made available to the Customer by AGRICARB within its facility, as defined by the Incoterm EX WORKS - CCI 2010 (hereafter referred to as the "Delivery").

AGRICARB and the Customer may agree upon EX-WORKS set prices (see table within these General Terms of Sales), carriage and packaging paid prices (see table within these General Terms of Sales), or free shipping on backorders.

Delivery times are given for information purposes only and may not lead to any type of compensation.

AGRICARB does not offer direct delivery to end-customers.

Litigation proceedings regarding Delivery:

- **The Customer has forty-eight (48) hours from the time of Delivery to report a claim with AGRICARB's customer service: +33 (0)4 78 04 28 47 or magasin@agricarb.com**

- **The Customer must state their precise, significant and complete reservations on the transportation documents.**

- **The reservations must bear on the goods and the visible aspect of the package. The more precise the reservations, the more indisputable they will be, leading to quicker examination of the claim and possible compensation.**

Mandatory details to report a claim:

- **State whether some pieces could be "missing" from the package or if the "pallet was delivered opened and damaged"**

- **Package n° / Order n°**

- **N° of damaged pallets or missing (ex. 1 damaged pallet out of 3 delivered pallets)**

- **In case of missing products: quantity and product references**

Any claim after this deadline or any missing information will lead to your claim being dismissed.

5. TERMS OF PAYMENT

For new customers, a payment on Pro-Forma invoice is required.

Payment of all invoices is due within a maximum of 30 days, counting from the end of the month following the date of issuance of the invoice.

No discounts will be granted for early payments.

Payment by the Customer of the sums due after the due date appearing on the invoice automatically entails the application of a fixed compensation of 40€ (articles L441-6 paragraph 12 and D441-5 of the commercial code). In the event of a legal and/or regulatory modification of the amount of this fixed compensation, the new amount will automatically replace the one appearing in these General Terms and Conditions. The automatic application of this compensation does not preclude the application of additional compensation for the claim upon justification, in accordance with the above-mentioned text, up to the entirety of the sums which will have been incurred by AGRICARB, whatever their nature, for debt recovery.

In case of overdue invoices, the amount due will be increased by a late payment penalty equal to three (3) times the legal interest rate per month from the due date.

AGRICARB reserves itself the right to ship orders through cash on delivery services.

Invoices shall be paid in full ; potential credit notes or other deductions (ex: guarantees) granted to the Customer shall be registered and deducted only once AGRICARB has issued a supporting accounting document.

Should the Customer not comply with the above terms of payment, AGRICARB reserves itself the right to suspend all

ongoing order shipments or to terminate its Contract with the Customer, without prior notice, in addition to any other action that AGRICARB would be entitled to pursue.

6. GUARANTEES

The products sold by AGRICARB are guaranteed contractually for a duration of six (6) months from the Delivery date. Said contractual guarantee only applies to technical defaults of the carbide plates.

No guarantee will be accepted in the following cases: misuse, negligence, lack or absence of maintenance on behalf of the Customer.

The wear, breakage or folding of the pieces are explicitly excluded from the guarantee.

Therefore, any AGRICARB pieces that have been altered by the Customer and/or a Third Party will not be accepted as part of a guarantee claim (hardfacing, welding...)

Only pieces that have been mounted on and used with AGRICARB bolting will be accepted as part of a guarantee claim.

Only pieces that still have carbide on them will be accepted as part of a guarantee claim.

Any return of goods shall be discussed and explicitly agreed upon beforehand by our sales and technical teams. Any approved return of goods to AGRICARB will be organized via a carrier, at the expense and risks of the Customer.

Upon examination of the returned products, AGRICARB will be the sole judge of the conformity or nonconformity of the products.

In the latter case, the returned product(s) will be accepted as part of a guarantee claim and replaced by a similar or equivalent product. No credit notes will be issued by AGRICARB.

7. LIABILITY

The full responsibility of AGRICARB is limited to the damage of property or persons directly caused to the Customer and solely attributable to the products and/or to a contractual non-performance on behalf of AGRICARB. The liability of AGRICARB with regards to the products sold to its Customers is explicitly excluded in the case of any indirect and/or non-physical damage, consecutive or not, suffered by the Customer and/or a Third Party, such as operating losses, loss or decrease of revenue, orders, clients, company image, etc. The latter may not give rise to any type of compensation on behalf of AGRICARB.

The liability of AGRICARB due to the products sold having caused damage to the Customer or a third party is expressly excluded in the event of misuse, negligence, or lack of maintenance on behalf of the Customer ; the same applies for normal wear and tear of the products or any Force Majeure event (as defined in article 12). As such, all of the previous may not lead to any type of compensation on behalf of AGRICARB.

8. RETURN OF GOODS

Returned unsold catalog products will be refunded at a discounted rate (between 20 and 50%).

The return of custom parts (i.e. parts not listed in the current catalog) and the resulting refund shall be agreed upon upfront between AGRICARB and the Customer.

9. RESERVATION OF OWNERSHIP

AGRICARB sells products to the Customer with a clause expressly subordinating the transfer of ownership of the property once full payment of the price in principal and accessories has been received. Consequently, in the event of non-payment, AGRICARB may repossess the delivered products, in addition to any other action that AGRICARB would be entitled to pursue.

It is understood, however, that the simple delivery of a document creating an obligation to pay, bank draft or otherwise, does not constitute a payment within the meaning of this clause, the original debt of AGRICARB on the Client subsisting with all the guarantees which therein are attached, including the retention of title until said commercial document has actually been paid.

The above provisions do not prevent, upon Delivery (see article 4) of the products, the transfer to the Customer of the risks of loss or deterioration of the products subject to retention of title as well as the damage that they could cause.

The Customer must take out insurance covering risks arising from Delivery of the goods.

Until the price has been paid in full, the Customer must individualize the goods delivered under this Contract. Materials in stock are presumed to be those unpaid.

In the event of seizure, or any other intervention by a third party, on the goods owned by AGRICARB, the Customer must inform AGRICARB without delay so that the company may oppose it and safeguard its rights.

The Customer further agrees not to pledge or transfer ownership of the goods as collateral.

The Customer is authorized, as part of the normal operation of its establishment, to resell the goods covered by this Contract.

However, should the Customer resell products that have yet to be paid for in full to AGRICARB by the due date, the latter commits to immediately paying the balance of the price remaining due to AGRICARB or to inform the sub-purchasers that said goods are the object of an ownership reserve clause and to notify AGRICARB of this transfer so that AGRICARB can safeguard its rights and, where applicable, exercise a claim on the resale price against the sub-purchaser.

10. INTELLECTUAL PROPERTY

Any and all technical documents sent to the Customer by AGRICARB remain the sole property of the latter, as the sole owner of the intellectual property rights of said documents.

Likewise, the intellectual property rights relating to the products remain the full and own property of AGRICARB or their rightful right owners. The Customer is given a right of usage of these intellectual property rights, on a purely personal, non-exclusive and non-transferable basis. This right of usage is strictly limited to the use of products and any technical documentation for internal purposes of the Customer, for France, for the product's lifetime. The Customer commits to not using any of said documents in such a way that could violate AGRICARB's industrial and/or intellectual property rights.

11. FORCE MAJEURE

AGRICARB may not be held responsible for any delay and/or non-performance due to force majeure, as defined by Article 1218 of the Civil Code, or in the event of a strike of its workforce, even if such event does not meet the legal or jurisprudential characteristics of force majeure (hereafter referred to as "Force Majeure"). Furthermore, AGRICARB's obligations toward the Customer will be suspended in the event of Force Majeure, until said Force Majeure event has been resolved.

12. GOVERNING LAW AND DISPUTES

These General Terms of Sales and the Contract are governed by French law. The application of the entirety of the Vienna Convention on Contracts for the International Sale of Goods of April, 11th 1980 is expressly excluded.

Should any difficulty or litigation arise relating to the validity, interpretation and/or the execution of these General Terms of Sales, the Parties will try their best to resolve the issue at hand amicably. Should the disagreement persist, the issue will be carried in front of the commercial court of Lyon.

A

ACTUB1210-22.....	165	BDD 7325.....	47	BEC7316.....	155	BRC7060.....	168
ACTUB1412-22.....	165	BDF 2317C.....	12	BEC7330.....	152	BTC1M1434.....	166
ACTUB1714-11.....	165	BDG 3417C.....	12	BEC7330-R.....	152	BTC1M1440-ES.....	166
ADA 0301.....	30	BDG 8392.....	13-22	BEC7343.....	155	BTC1M1440-NY.....	166
ADA 3310.....	52	BDJ 7050.....	54	BEC8330.....	155	BTC2M1239.....	166
ADA 4810.....	52	BDK 0470.....	54	BGRA 1967.....	110	BTC2M1245.....	166
ADA 8679.....	30	BDK 1245C.....	15	BGRS 1966.....	110	BTC2M1250.....	166
ADB 0351.....	53	BDK 1320.....	54	BICA 1254.....	116	BTC2M1264.....	166
ADB 0447.....	30	BDK 2229.....	14	BICU 0080-HR.....	118	BTC2M1439.....	166
ADD 0450.....	30	BDK 2229V.....	14	BICU 0105-HR.....	118	BTC2M16115-NY.....	166
ADF 3267.....	30	BDK 2230.....	14	BICU 0135-HR.....	118	BTC2M1690-NY.....	166
ADG 0087.....	31	BDK 3050.....	18	BICU 0150-HR.....	118	BTCAC1325.....	165
ADG 0280.....	31	BDK 3090.....	18-21-22	BICU 0175-HR.....	118	BTCAC1330.....	165
ADG 0440.....	31	BDK 5247.....	16	BICU 0200-HR.....	118	BTCHC12150.....	166
ADGO 1004.....	54	BDK 6068.....	15	BLA 0090.....	45	BTCHC1225.....	166
ADH 0854.....	32-35	BDK 7920B.....	17	BLD 0049.....	48	BTCHC1435.....	166
ADH 0856-HYG.....	32	BDK 7920C.....	18	BLD 0070.....	48	BTCHC1445.....	166
ADH 0856.....	30-32-34-35	BDK 7920P.....	NEW 18	BLG 0117-RS.....	45	BTCHC1670.....	166
ADH 8883.....	32	BDK 9430.....	15	BLG 7236.....	45	BTCHC1680.....	166
ADH 9058.....	32	BDKD 9430.....	16	BLK 0161.....	54	BTF2E1235.....	165
ADK 0005.....	32	BDL 0220.....	18	BLM 6022.....	44	BTF2E1440.....	165
ADK 0125.....	33	BDL 220V.....	10-16-18-20-23	BLM 7234.....	44	BTF2E1450.....	165
ADK 1123.....	33	BDL 4386.....	18	BLR 0085.....	44	BTFCC1035.....	167
ADK 1402.....	54	BDL 4441B.....	12-18	BLR 0085.....	140	BTFCC1040.....	167
ADK 4701.....	34	BDL 4441C.....	12-19	BLR 6233.....	44	BTFCC1050.....	167
ADK 6015.....	32-34	BDL 4441P.....	12-19	BOA0135.....	152	BTFCC1050-ECL.....	167
ADK 6025.....	32	BDL 4442.....	12-19	BOA1264.....	152	BTFCC1060-ECL.....	167
ADK 6055.....	32	BDL 7106.....	19	BOA1267.....	152	BTFCC1060-NY.....	167
ADK 7032.....	32	BDL 8012.....	19	BOA1268.....	152	BTFCC1070-ECL.....	167
ADK 7186.....	34	BDLD 4441N.....	20	BOR0030.....	158	BTFCC1070-NY.....	167
ADK 8180.....	33	BDP 0151B.....	21	BOR0045.....	158	BTFCC12100.....	167
ADL 0018.....	34	BDP 0151C.....	21	BOR0046.....	158	BTFCC12120.....	167
ADL 0020.....	34	BDP 0151P.....	21	BOR0050.....	158	BTFCC1235.....	167
ADL 0360.....	34-36	BDP 5248.....	22	BOR0060.....	158	BTFCC1240.....	167
ADL 360C.....	30-32-34-36	BDP 6320-R.....	55	BOR0070.....	158	BTFCC1250.....	167
ADL 4428.....	34	BDQ 2214.....	22	BOR0080.....	158	BTFCC1250-10-ECL.....	165
ADL 4460.....	30-34	BDR 0310.....	23	BOR0090.....	158	BTFCC1255.....	167
ADP 0240.....	34	BDR 1667.....	23	BOR0092.....	158	BTFCC1260.....	167
ADP 0250.....	35	BDR 200V.....	23	BOR0106.....	156	BTFCC1270.....	167
ADP 0300.....	35	BDR 310V.....	23	BOR0107.....	156	BTFCC1270-10-EC.....	165
ADQ 4012.....	35-36-136	BDR 4428.....	55	BOR0108.....	156	BTFCC1280.....	167
ADQ 5012.....	30-35-36-136	BDR 8040.....	55	BOR0126.....	156	BTFCC1285.....	167
ADQ 5014.....	31-33-35-36-136	BDS 7050.....	54-55-140	BOR0127.....	156	BTFCC1290.....	167
ADR 0060.....	36	BDS 7050-S.....	44-52	BOR0129.....	156	BTFCC1290-10-EC.....	165
ADR 0075.....	36	BDU 0701.....	24	BOR0130.....	156	BTFCC14100.....	167
ADR 0290.....	36	BDU 2065C.....	10-24	BOR0135.....	158	BTFCC1440.....	167
ADR 0290.....	36	BDV 0002.....	55	BOR0180.....	158	BTFCC1450-NY.....	167
ADR 4404.....	55	BDV 2854C.....	24	BOR0225.....	158	BTFCC1460.....	167
ADS 0392.....	60	BDV 3698.....	24	BOR1066.....	154	BTFCC1460-12.....	165
ADS 9708.....	31-36	BDV 7618.....	24	BOR1261.....	154	BTFCC1470-NY.....	167
ADU 3214.....	30-36-36-137	BDV 8117.....	24	BOR1262.....	154	BTFCC1480.....	167
ADV 5001.....	36	BDV 8441.....	24	BOR1263.....	154	BTFCC1490.....	167
		BDV 9233B.....	24	BOR1264.....	154	BTFCC1490-12.....	165
		BDV 9233C.....	24	BOR1265.....	154	BTFCC16115-NY.....	167
		BDV 9233P.....	25	BOR1266.....	154	BTFCC1640-CC.....	165
		BDV 9998.....	131	BOR1267.....	154	BTFCC1660-NY.....	167
		BEBAC9013.....	165	BOR1268.....	154	BTFCC1670-NY.....	167
		BEC1224B.....	154	BOR1269.....	154	BTFCC1690-NY.....	167
		BEC1230.....	155	BOR180C.....	158	BTFCCW-12100.....	165
		BEC5213.....	155	BOR3611.....	154	BTFCCW-1235.....	165
		BEC6216.....	155	BRC0760.....	168	BTFCCW-1240.....	165
		BEC6217B.....	155	BRC0870.....	168	BTFCCW-1250.....	165
		BEC6230.....	155	BRC1050.....	168	BTFCCW-1255.....	165
		BEC7216.....	155	BRC1060.....	168	BTFCCW-1260.....	165
		BEC7217B.....	154	BRC1070.....	168	BTFCCW-1270.....	165
		BEC7230.....	155	BRC12060.....	168	BTFCCW-1280.....	165
		BEC7235.....	155	BRC12070.....	168	BTFCCW-1285.....	165

B

SMV 5996	24	VAGA 5400	136
SOC 0050	28-134	VAGA 5700	136
SOC 0060	28-134	VAGR 0131	NEW 46
SOC 0060-RV	28-134	VBKI 8342	140
SOC 0060-XT	28-134	VDBO 3747	144
SOC 0200	28	VDBO 3748	144
SOC 0202	28	VGBO 3300	134
SOC 0203	28	VIAC 8202	144
SOC 0212	28	VIAC 9175	144
SOC 060A	28	VIAC 9271	144
SOC 060A	135	VIBO 9592	144
SOC 060F	28-135	VIBO 9593	144
SOC 203V	26-29-134	VIBO 9594	144
SOC 213V	18-26-29-134	VIBR 1131	144
SOC 4050	29-135	VIBR 2151	144
SOC 6070-XT	29	VICL 0257	145
SOC 6836	134-135	VICL 5316	145
SOC 6836F	134	VIFE 1100	145
SOC 7080	29	VIFE 8600	145
SRH 0018	124	VISP 0400	145
SRH 2012	124	VISP 0540	NEW 145
SRH 3301	124	VRBO 3021	142
SRM 0141	124	VRBO 3025	142
SRM 5060	124	VSBO 3125	143
SRM 7282	124	VSBO 3127	143
SRR 7142	124	VSDC 2160	148
SRR 7168	124	VSGA 5500	142
SRV 0500	124	VSGA 5900	142
SRV 0501	124	VSTB 3011	138
STB 0173	38-138	VSTB 3013	138
STC 2560M	38	VSTB 3014	138
STF 0236M	38-138	VSTB 3053	138
STH 1511M	38		
STH 7505	38		
STH6759	38		
STK 0584M	39		
STK 4032M	38		
STK 4032M-12	38		
STK 7658M	38		
STKU 3170M	39		
STKV 0235M	39		
STL 0066	39		
STL 0080	NEW 39		
STL 4356M	39		
STT 0260	40		
STT 0300	NEW 40		
STU 1810M	40-138		
STU 2512M	40-138		
STU 3012M	40-138		
STU 3812M	40-138		
STV 5038	40		
SVI 0030-R	107		
SVI 0030-XT	108		
SVI 1335P-HR	108		
SVI 1835-HR	108		
SVI 2039	130		
SVI 5010	108		
SVI 5012	108		
SVI 6010	108		
SVI 6012	108		



V	
VAFE 6600	136
VAGA 0006	136
VAGA 0007	136
VAGA 0400	136
VAGA 4600	136

Notes

Nota | notiz | note

A series of horizontal dotted lines for writing notes, starting from the top right of the page and extending downwards.

Notes

Nota | notiz | note

A series of horizontal dotted lines for writing notes.

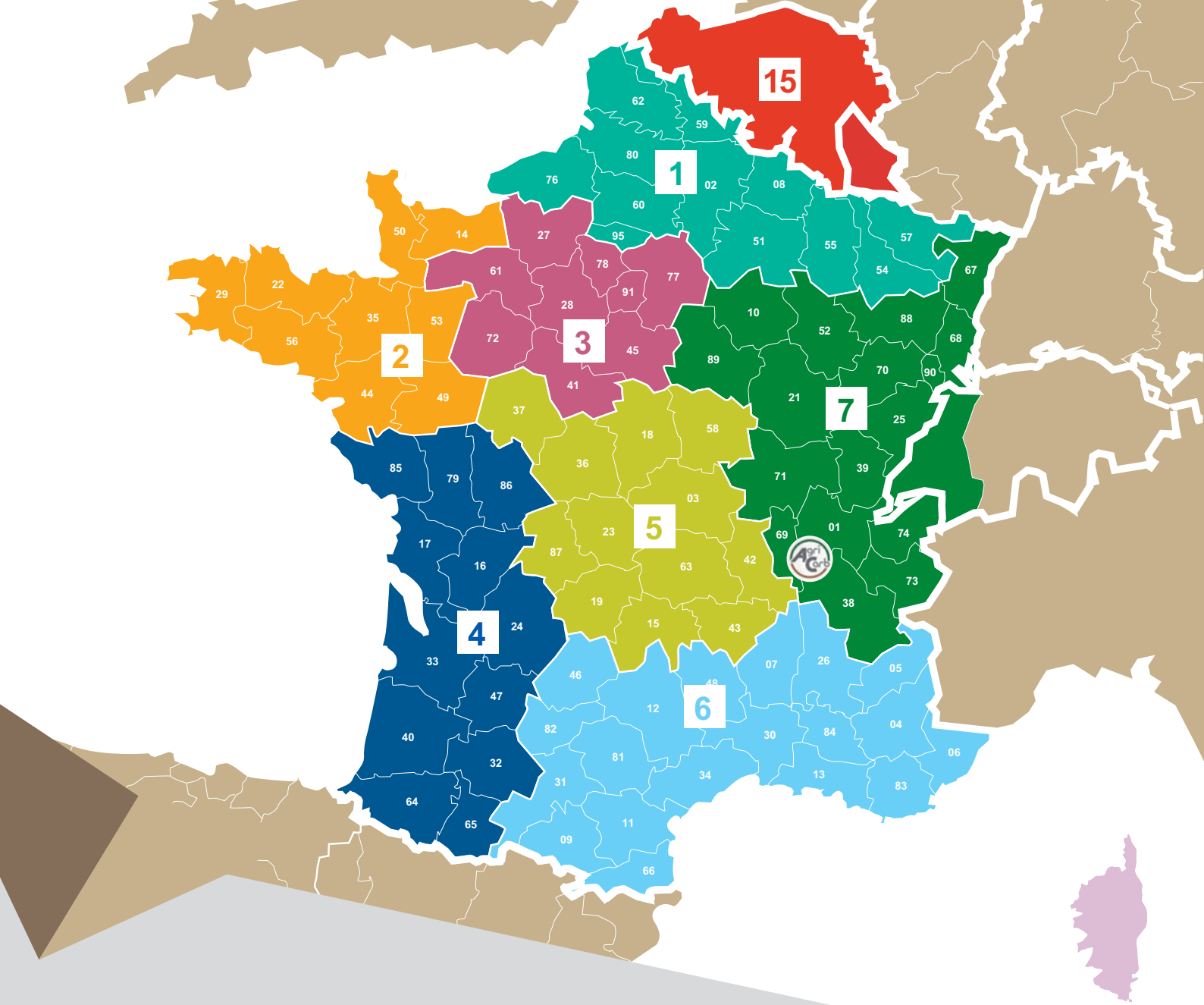

Arnaud WYNANDS
 Directeur Commercial France

Gaëlle MACALUSO
 Assistante commerciale France
 gaelle.macaluso@ceratizit.com
 T 04 78 04 28 47

1 **Lucie MOUY**
 Technico-Commerciale
 Secteur Nord
 lucie.mouy@ceratizit.com
 M 06 19 72 85 61

4 **David DEFFRENE**
 Technico-Commercial
 Secteur Ouest
 david.deffrene@ceratizit.com
 M 06 48 14 94 02

7 **Benoît DALAS**
 Technico-Commercial
 Secteur Grand-Est et Suisse
 Romande
 benoit.dalas@ceratizit.com
 M 06 13 96 41 16

2 **Ludovic GLORY**
 Technico-Commercial
 Secteur Bretagne
 ludovic.glory@ceratizit.com
 M 06 22 99 69 67

5 **Jean-Marc PECHON**
 Technico-Commercial
 Secteur Centre
 jean-marc.pechon@ceratizit.com
 M 06 20 26 44 75

3 **Christophe PILLAULT**
 Technico-Commercial
 Secteur Beauce
 christophe.pillault@ceratizit.com
 M 06 20 23 36 33

6 **Richard LLOPIS**
 Technico-Commercial
 Secteur Sud
 richard.llopis@ceratizit.com
 M 06 18 12 50 54

15 **Damien LAMBRECHT**
 Importateur Benelux
 CARBILAM
 info@carbislam.be
 T 0032 (0)474 636 884

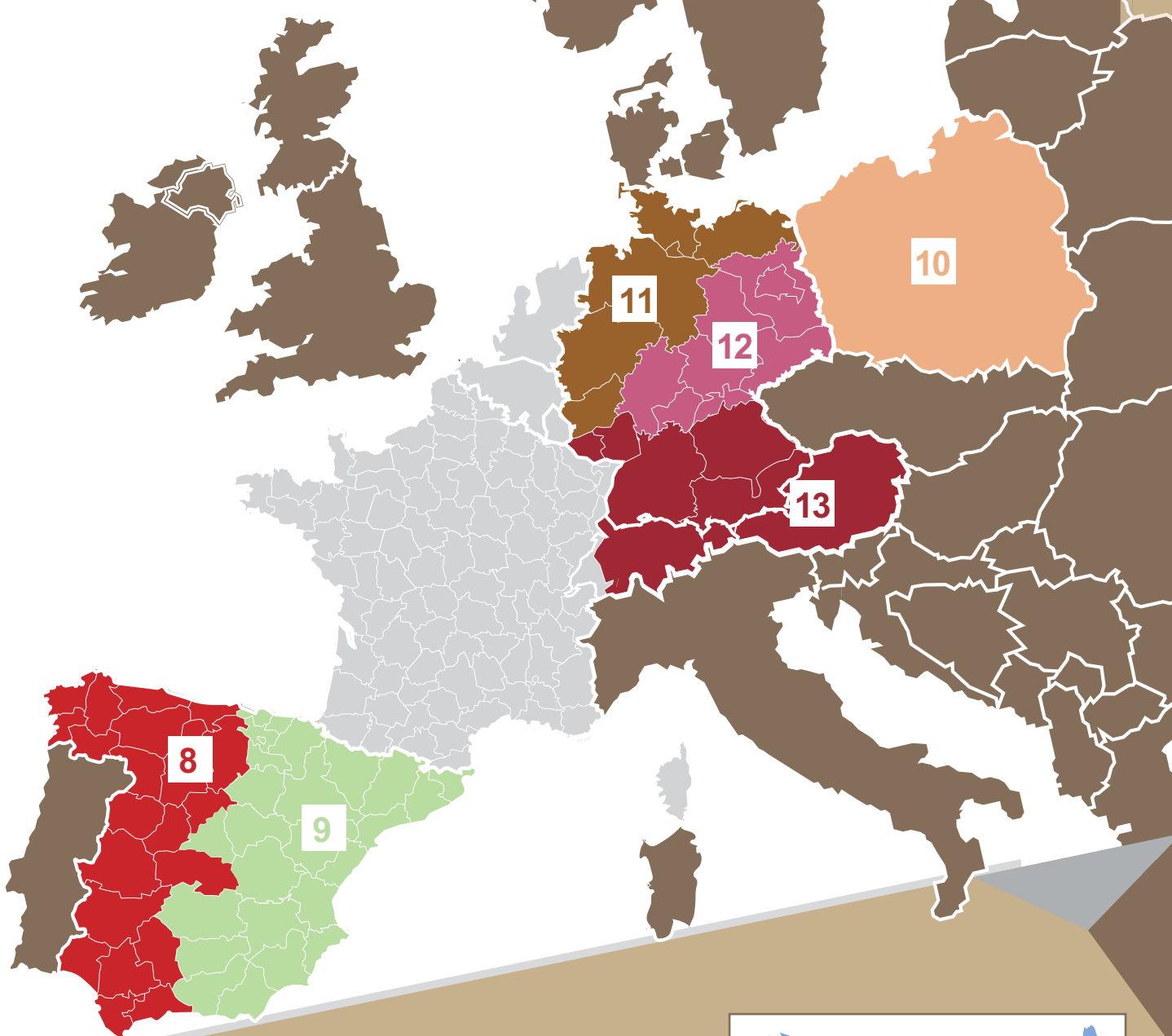

Marta FONT

Export Sales Manager
 marta.font@ceratizit.com
 M +49 (0)151 5444 0651

Camille-Elisa PERRY

Export Sales Assistant
 camille-elisa.perry@ceratizit.com
 T +33 478 047 811

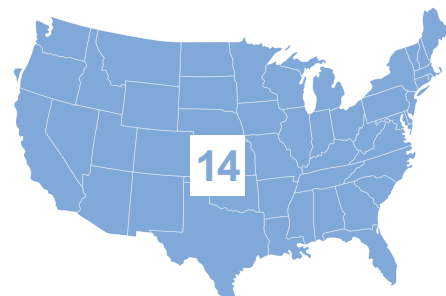

14

François PASTOL

Sales Representative USA
 françois.pastol@ceratizit.com
 M +1 (331) 286-6658

8

Luis CALOCA ROLDAN

Responsable comercial
 Espana
 luis.caloca@ceratizit.com
 M +34 602 571 935



11

Martin REHLING

Außendienst Mitarbeiter
 Deutschland West U. Nord
 martin.rehling@ceratizit.com
 M +49 (0)172 376 7449



9

Luis CALOCA ROLDAN

Técnico comercial
 Zona Este
 luis.caloca@ceratizit.com
 M +34 672 248 396



12

Alexander REICHERT

Außendienst Mitarbeiter
 Deutschland Ost u. Mitte
 alexander.reichert@ceratizit.com
 M +49 (0)152 54 66 97 31



10

Aron GRELICH

Technical Sales Expert
 Polska
 aron.grellich@ceratizit.com
 M +48 667 756 067



13

Sebastian NEUMEISTER

Deutschland Süd,
 Österreich u. Schweiz
 sebastian.neumeister@ceratizit.com
 M +49 (0)173 604 09 94



CERATIZIT GROUP

AGRICARB S.A.S

8, rue Jean Macé
 69330 Meyzieu FRANCE
 contact@agricarb.com
 Tél. : +33 478 042 847



HEADQUARTERS : CERATIZIT S.A.

LU-8232 Mamer T.
 Tél. : +352 31 20 85-1
 ceratizit.com

AGRICARB S.A.S - CERATIZIT LYON
8, rue Jean Macé
69330 MEYZIEU
FRANCE
Tél. : +33 (0)4 78 04 28 47
e-mail : contact@agricarb.com
www.agricarb.com

L'origine du carbure agricole

The roots of agricultural carbide

Der Ursprung von Hartmetall für die Landwirtschaft

El origen del carburo agrícola



CERATIZIT GROUP

AGRICARB, l'inventeur de la pièce d'usure agricole au **carbure de tungstène**.

— — Made in France